

Elite Wrought Iron

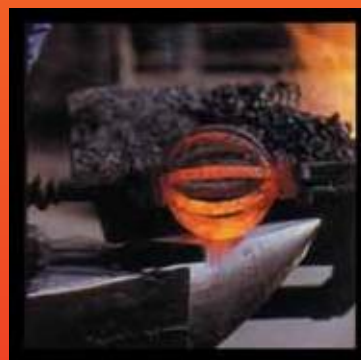

**UNIT 3-48 KREMZOW ROAD
BRENDALE, BRISBANE QLD 4500
PHONE: 0400 455 188
WEB SITE: www.elitewroughtiron.com.au
EMAIL: info@elitewroughtiron.com.au**

Throughout history, Iron has been shaped by the Blacksmith, an expert craftsman. It is a tradition not easily replaced or forgotten. Elite Wrought Iron has the ability to produce such items of elegance. This catalogue is a selection of what may be produced. If you have your own design, fax it to us for appraisal.







INDEX



	Page
<i>Balusters</i>	1-15
<i>End Posts</i>	16
<i>Top Rails</i>	17
<i>Top Rail Ends, Circles & Infills</i>	17
<i>Hammered Products</i>	18
<i>Twisted Tube</i>	18
<i>Twisted Rope</i>	18
<i>Wrought Iron Panels</i>	20
<i>Collar Material</i>	22
<i>Rosettes</i>	22
<i>Snap Ons & Decorative Chain</i>	23
<i>Forged Ornaments</i>	24
<i>Mounting Plates & Bases</i>	25
<i>Spear Tops & Forged Spears & Tops</i>	26
<i>Hammered Scrolls</i>	27
<i>Scrolls</i>	28
<i>Hot Rivetted Balusters</i>	31
<i>Security Door infills</i>	46
<i>Roses & Rose Leaves</i>	47
<i>Baskets, Baluster Knobs, Balls, Rivets</i>	48
<i>Sheet Metal Items, Candle Dishes & Cups</i>	49
<i>Flowers, Grapes & Grape Leaves</i>	50
<i>Pressed & Stamped Leaves</i>	51
<i>Gate Tops</i>	52
<i>Decorative Gate Locks</i>	53
<i>Hinged & Sliding Gate Accessories</i>	54-57
<i>Cantilevered Sliding Gate System</i>	58
<i>Catalogues of Wrought Iron</i>	59
<i>Patina Paints</i>	60
<i>Aluminium Products</i>	61-67

Elegance from fire...
Strength from hammer



Balusters

All balusters 12mm x 12mm square unless specified



NB1-01
H=1000mm



NB1-02
H=1000mm



NB1-03
H=1000mm



NB1-04
H=1000mm



NB1-05
H=1000mm



NB1-06
H=1000mm
x 220mm

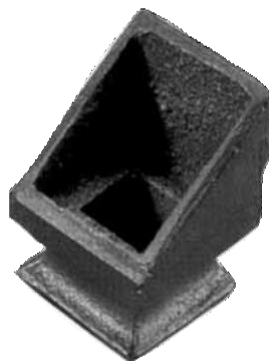

NB1-08
30 x 50mm
□13mm hole

Angle cut to suit requirements on order

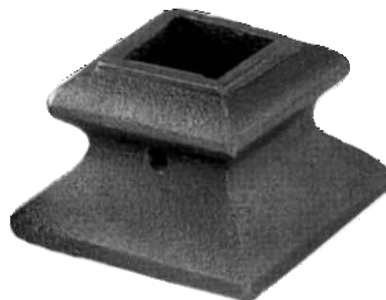

NB1-09
40 x 28mm
□13mm hole



12mm Balustrade Cover Plates can be used to conceal hole into timber balustrading as per page 12.

112mm

100mm



NB1A-01
12x1000mm

NB1A-02
12x1000mm

NB1A-03
12x1000mm

NB1A-04
12x1000mm

NB1A-05
12x1000mm

NB1A-06
12x1000mm

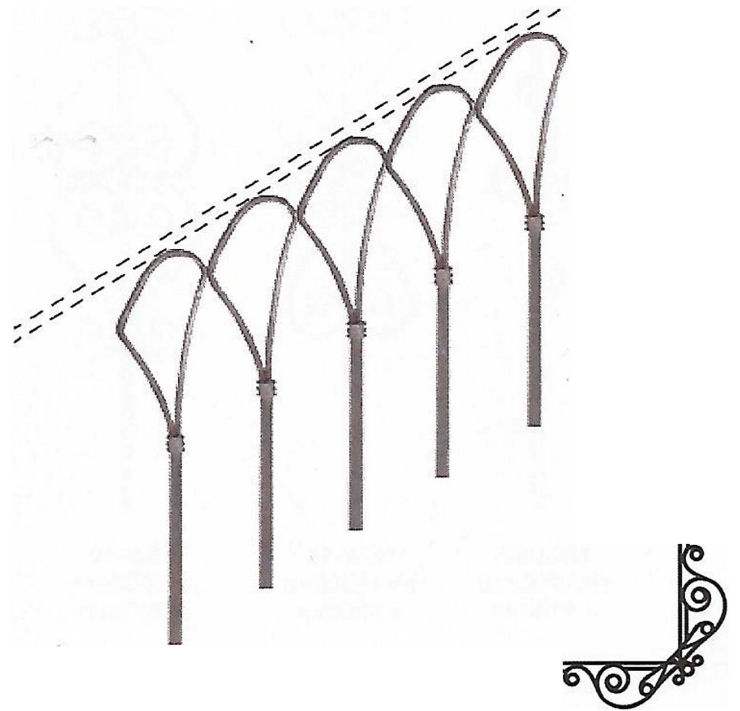
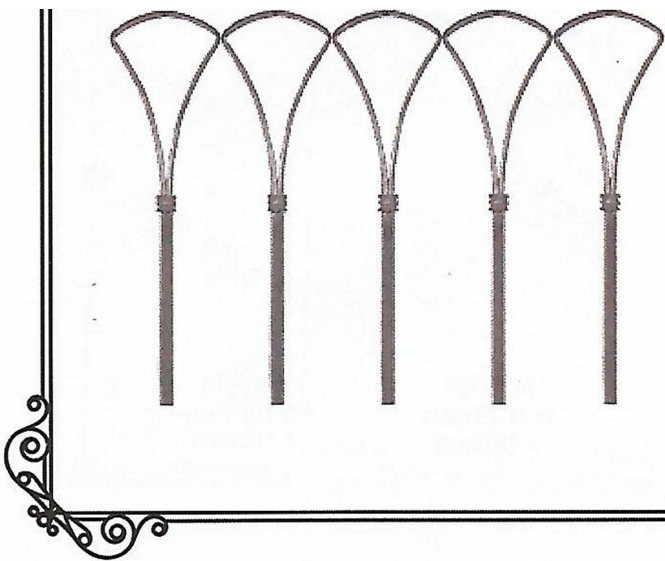

Balusters

All balusters 12mm x 12mm square unless specified



NB2-01
H=1000mm
285mm twist

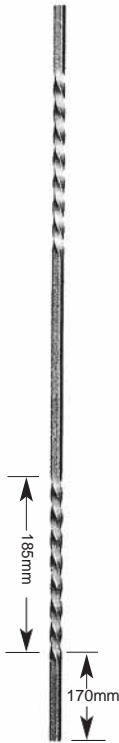

NB2-02
H=1000mm



NB2-03
H=1000mm
700mm twist



NB2-07
H=1000mm
x 170mm



NB2-08
H=1000mm
x 170mm



NB2-08A
20 X 3 mm
900mm



NB2-09
H=1000mm
x 110mm



NB2-10
H=1000mm
x 130mm



NB2-11
H=1000mm
x 180mm

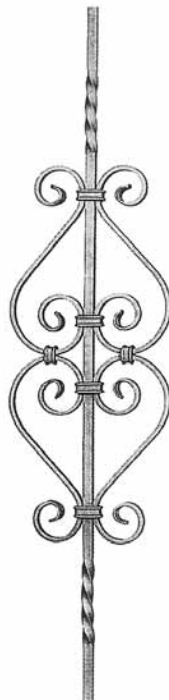

NB2-12
H=1000mm
x 200mm

FISH HOOK BALUSTERS
INDIA 1066/4
1066/5



NB2A-01
12mm Round
1000mm long

NB2A-02
12mm \circ
1000 mm

NB2A-03
12mm \circ
1000mm



NB2A-04
12mm \circ
1000 mm

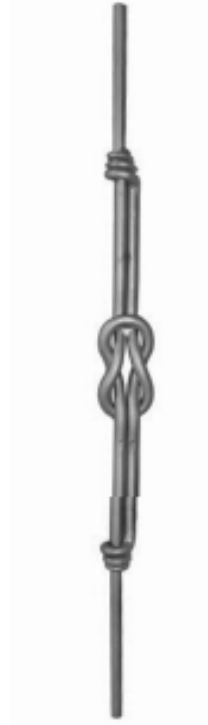

NB2A-05
12mm \circ
1000mm



Art. 20E/09
H.900xL.120mm

Art. 20E/10
H.900mm

Art. 20E/11
H.900mm

1035 long x 128
wide
1.675 kgs
x 54 off????

900 long
750 grams
185 off????

900 mm long
750.grams
185 Off?????

Balusters

All balusters 12mm x 12mm square unless specified



NB3-01
H=1000mm



NB3-02
H=1000mm



NB3-06
H=900mm
x 220mm

BACK WALL
SHED 3
SIMILAR TO
NB3-09

RECTANGULAR
PATTERN S
18 X 895 OA
24 X 830 O/A
PATTERN 690 X 125 OA



NB3-30
12 mm round
1mtr x 260mm



NB3-09
H=1000mm
x 220mm



NB3-10
H=1000mm
x 215mm



NB3-15



NB3-16

BAMBOO BALUSTERS



NB3A-01
16 solid ROUND
BASE
1000mm long



nb3A-02
30 MM ROUND
END POST
1000 MM LONG



NB3A-03
BAMBOO TUBE
3 MTRS LONG

SEAWEED BALUSTERS



NB6A-01
1000MM LONG
14 MM ROUND
BASE WAVE IS
400 MM



NB6A-02
1000 MM LONG
14 MM ROUND
BASE WAVE IS 400,MM



NB6A-03
1000 MM LONG
14 MM ROUND BAR
WAVE PATTERN IS 800
MM LONG

SNAKE BARS



NB6A-08
1000 MM LONG
12 MM ROUND
BAR



NB6A-09
1000 MM LONG
12 MM ROUND
BAR

Balusters

All balusters 12mm x 12mm square unless specified



NB4-01
H=1000mm



NB4-02
H=1000mm

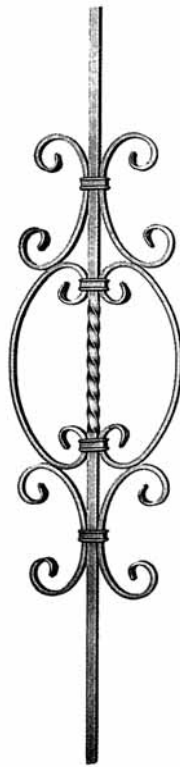

NB4-03
H=1000mm



NB4-04
900mm



NB4-06
H=1000mm



NB4-07
H=1000mm
x 180mm



NB4-08
H=1000mm
x 235mm



NB4-09
H=1000mm



NB4-10
H=1000mm

Balusters



NB6-01
900 x 200mm



NB6-02
1000 x 200mm



NB6-03
900 x 200mm



NB6-04
900 x 200mm



NB6-05
900 x 140mm



NB6-06
900 x 140mm



NB6-07
280 x 140mm
12 x 6mm



NB6-08
180 x 140mm
12 x 6mm



NB6-09
900 x 200mm
100mm Ring



NB6-10
900 x 200mm

Custom lengths can be ordered on these balusters

Balusters

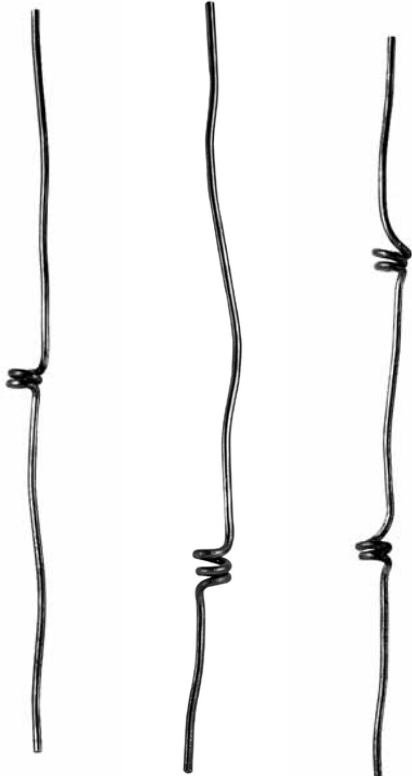

NB11-01
1000mm
Ø12mm

NB11-01A
1000mm
12 mm round

NB11-02
1000mm
Ø12mm

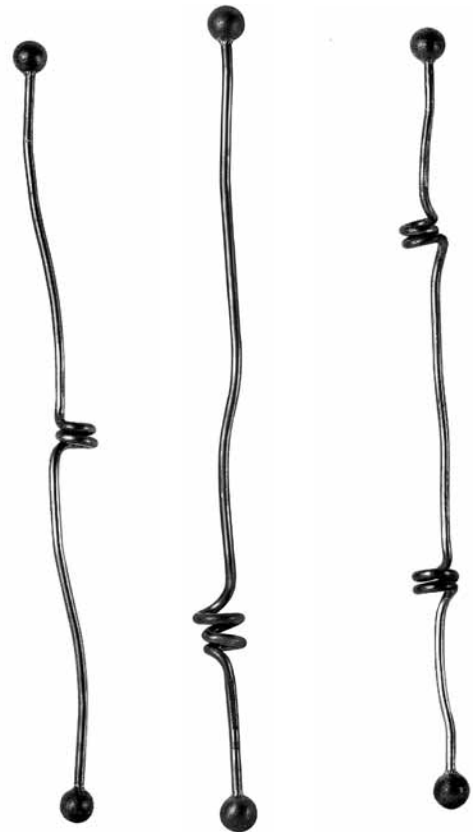
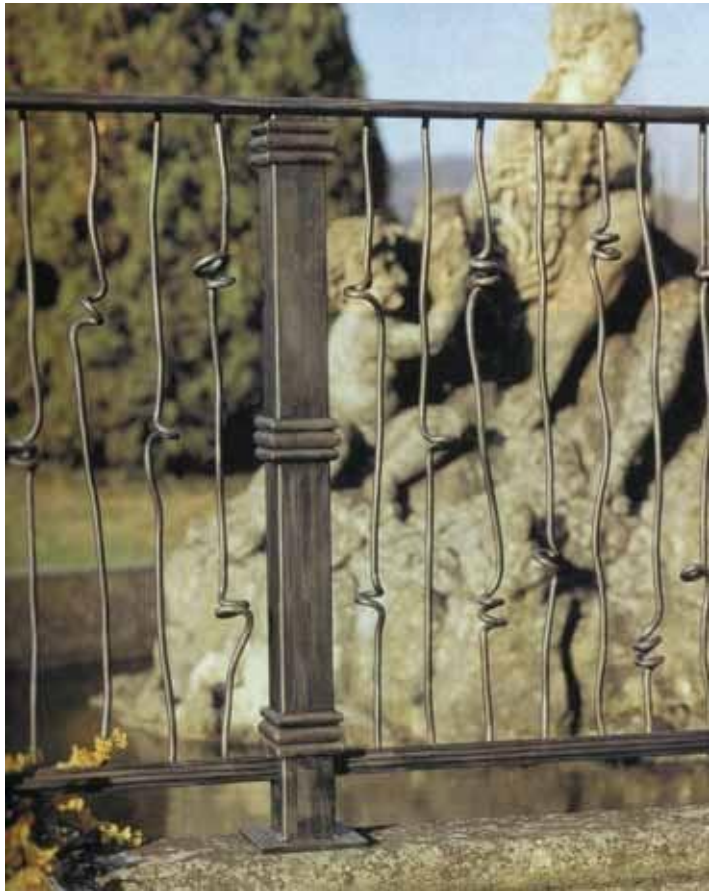

NB11-03
1000mm
Ø12mm

NB11-03A
1000mm
12 mm Round

NB11-04
1000mm
Ø12mm

Balusters

All balusters 12mm x 12mm square unless specified



NB10-01
900 x 230mm



NB10-02
900 x 230mm



NB10-03
900 x 230mm



NB10-04
900 x 230mm

Hot Rivetted Balusters



NB31-03
1000 x 180mm
⌀ 12mm



NB31-04
1000 x 100mm
⌀ 12mm



NB31-05
1000 x 100mm
⌀ 12mm



NB31-06
1000 x 200mm
⌀ 12mm



NB31-07
1000 x 180mm
⌀ 12mm



NB31-08
1000 x 200mm
⌀ 12mm



NB31-09
1000 x 200mm
⌀ 12mm



NB30-01
1000 X 210 MM
Pattern comes with
Brass ornament



NB30-02
1000 x 210mm
No brass
ornament

NB30-03
Double sided
brass ornament



NB33-01
1000 x 200mm
Using double sided
brass ornament

BALUSTER PATTERNS



NB5-01
870 x 350mm
12 x 6mm



NB5-02
900 x 370mm
Ø14mm



NB5-03
800 x 270mm
□8 x 8mm

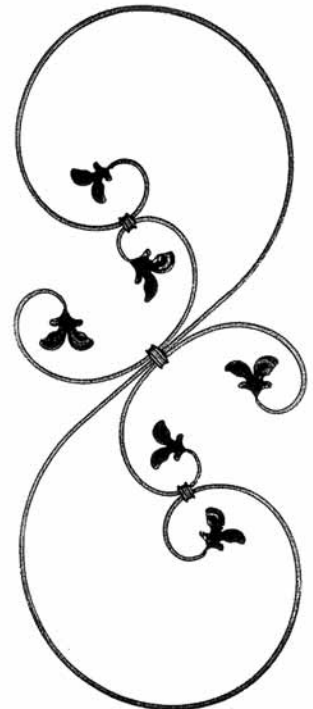

NB5-04
870 x 350mm
12 x 6mm



NB5-04B
920 MM X 470 MM ON A 30
DEGREE RAKE
VERTICAL LEGS 14 MM
ROUND

18 off ???

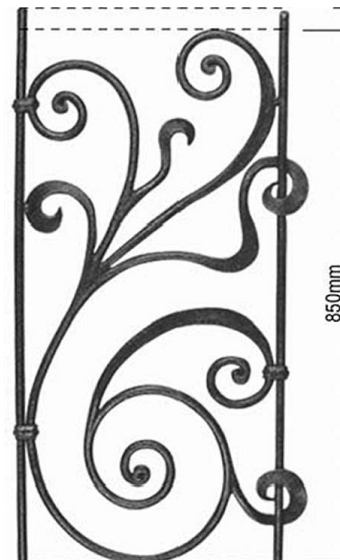

NB5-04C
PATTERN 850 MM HIGH
VERTICAL LEGS 920MM HIGH
VERTICAL LEGS 14 MM ROUND

12off ????

Pressed Balustrades



NB15-01
1000mm



NB15-02
1000mm



NB15-03
1000mm



NB15-04
1000mm



NB15-05
1000mm



NB15-06
1000mm



NB15-07
1000mm

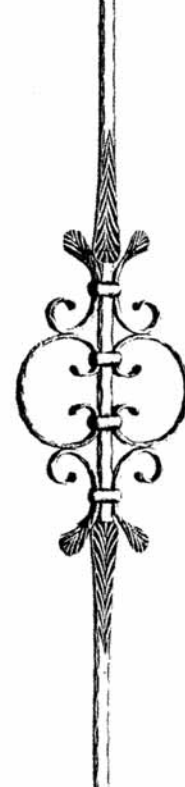

NB15-08
1000mm

Pressed Balusters

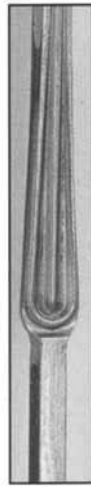

NB14-01
1000mm
∅12mm

NB14-02
1000mm
∅12mm

NB14-03
1000mm
∅12mm

NB14-04
1000mm
∅12mm

NB14-05
∅12mm
1000mm
NB14-06
∅14mm
1000mm

NB14-07
∅12mm
1000mm
NB14-08
∅14mm
1000mm



NB14-09
1000mm
∅12mm

NB14-10
1000mm
∅12mm

NB14-11
1000mm
∅12mm

NB14-12
1000mm
∅12mm

NB14-13
1000mm
∅12mm

NB14-14
1000mm
∅12mm

NB14-15
1000mm
∅12mm

NB14-16
1000mm
∅12mm

PRESSED

Balusters

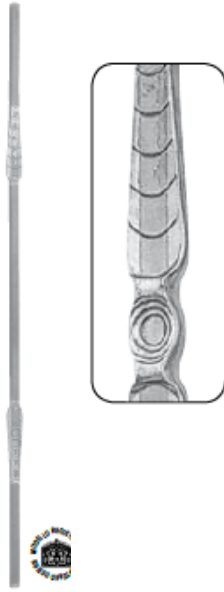

PR-51
INDIA 1702/5
1.3 KGS

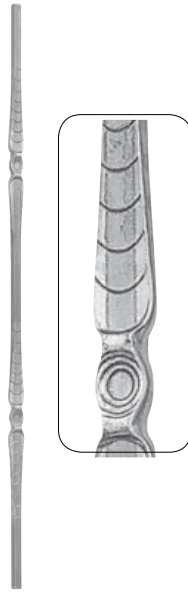

PR67
12 X 12 MM
1000MM LONG



PR65
12 X 12 MM
1000 LONG



PR 57
INDIA 1705/4
14 X 14 MM
1 MTR LONG 1.4 KGS



PR52
INDIA 1705/1
1.1 KGS
12 X 12 MM



PR53
INDIA 1705/2
CHECK SIZE
MATERIAL



PR60
8028-4
14X 14 MM
1000MM LONG

THINK NO STOCK



FBZ-125
CTR PIECE 160 X
150MM
14 X 14



Shaped Balusters



NB5-05
H= 800mm
40 x 4mm



NB5-06
900 x 125mm
⌀12 x 12mm



NB5-07
H= 900mm
⌀12 x 12mm

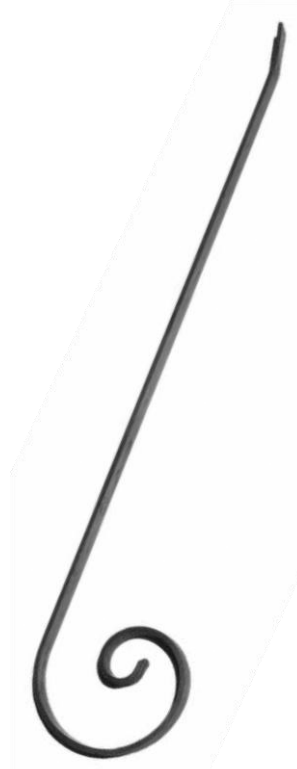

NB5-08
900 x 200mm
⌀20 x 6mm



NB5-09
900 x 200mm
⌀12 x 12mm

SHAPED BALUSTERES



NB5A-01
14 X 14 MM
1000mm LONG



NB5A-02
14 X 14 MM
1000mm LONG



NB5A-03
12 x 12 x 1000mm
200 mm off set



NB 5A-04

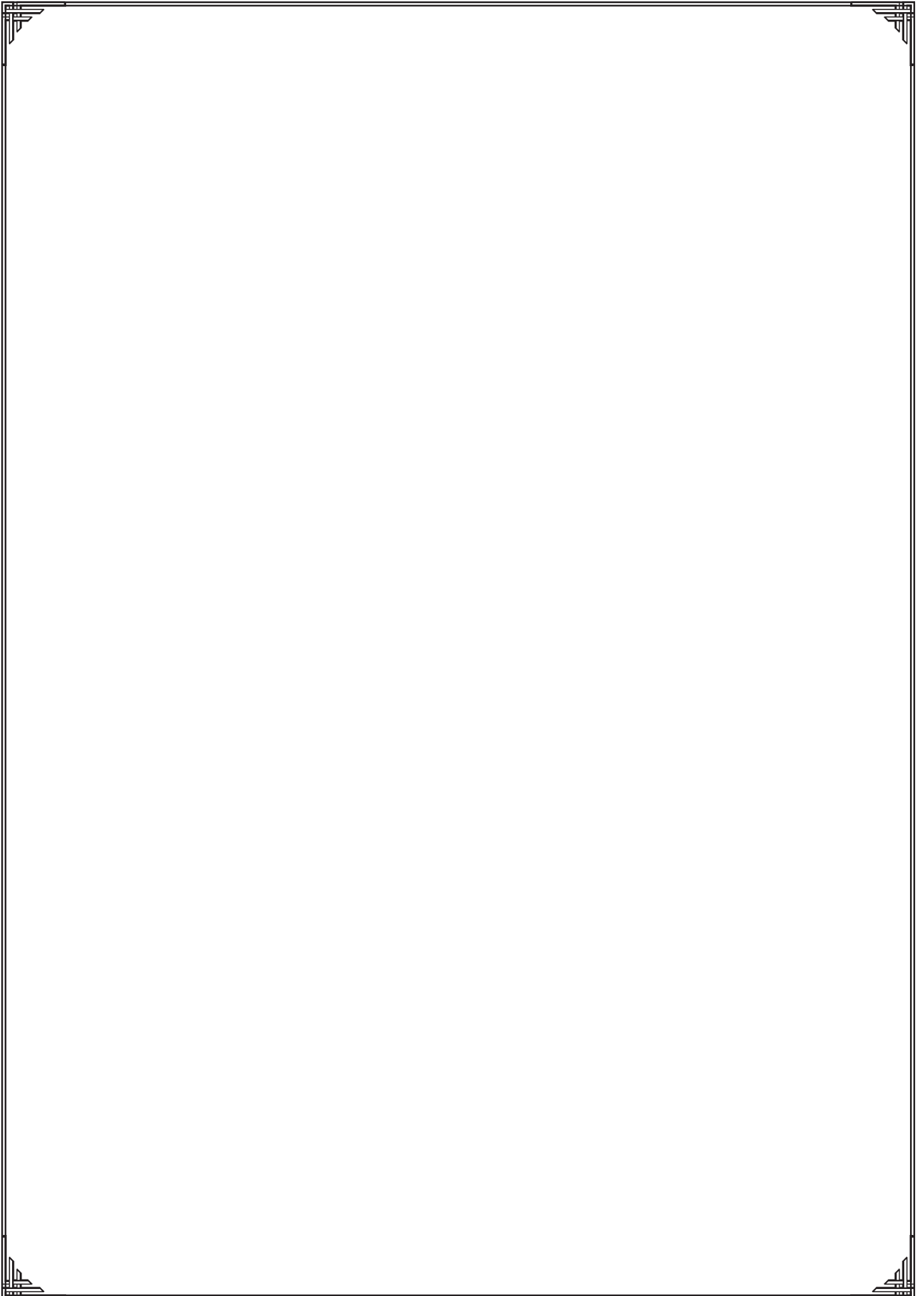

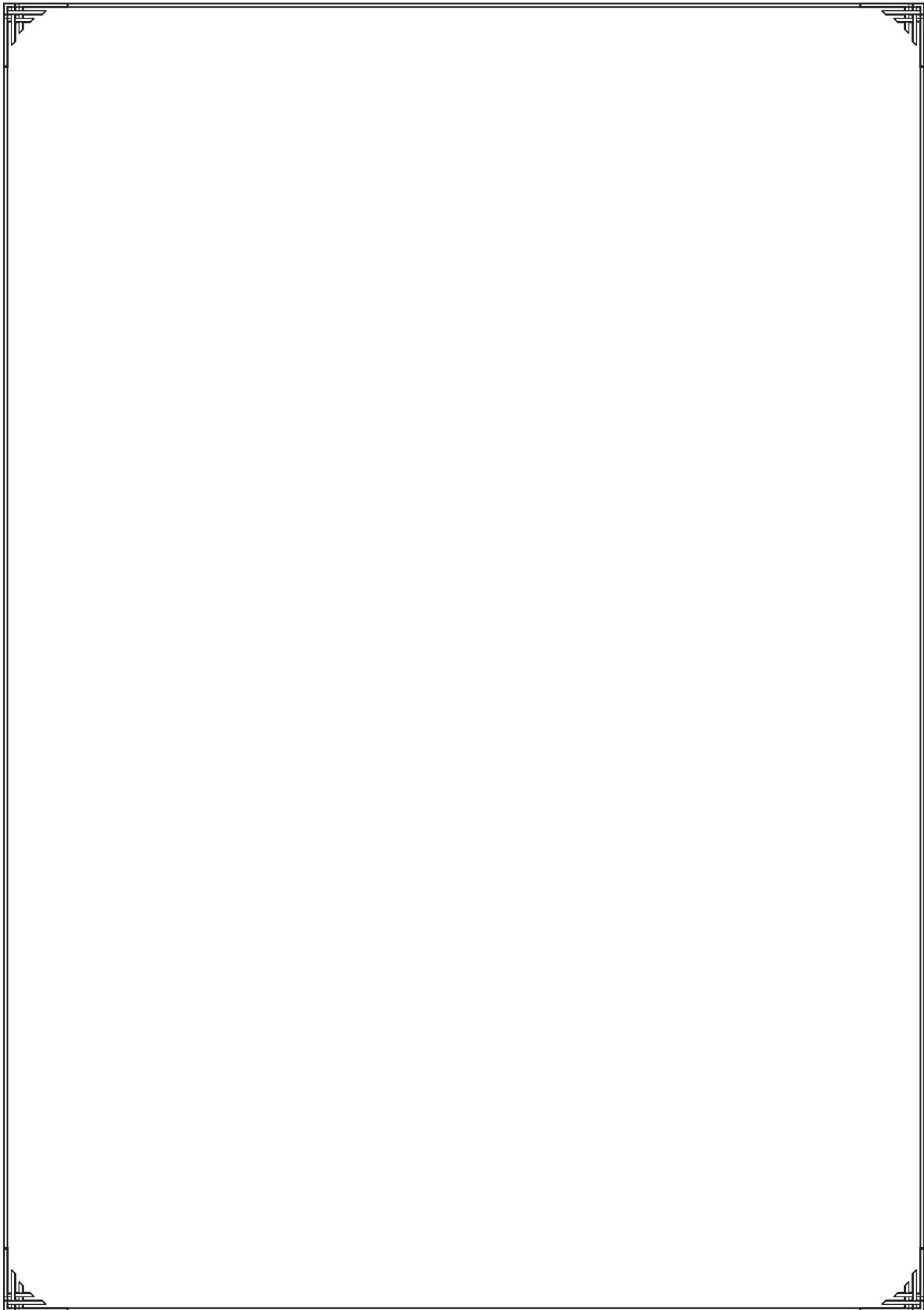

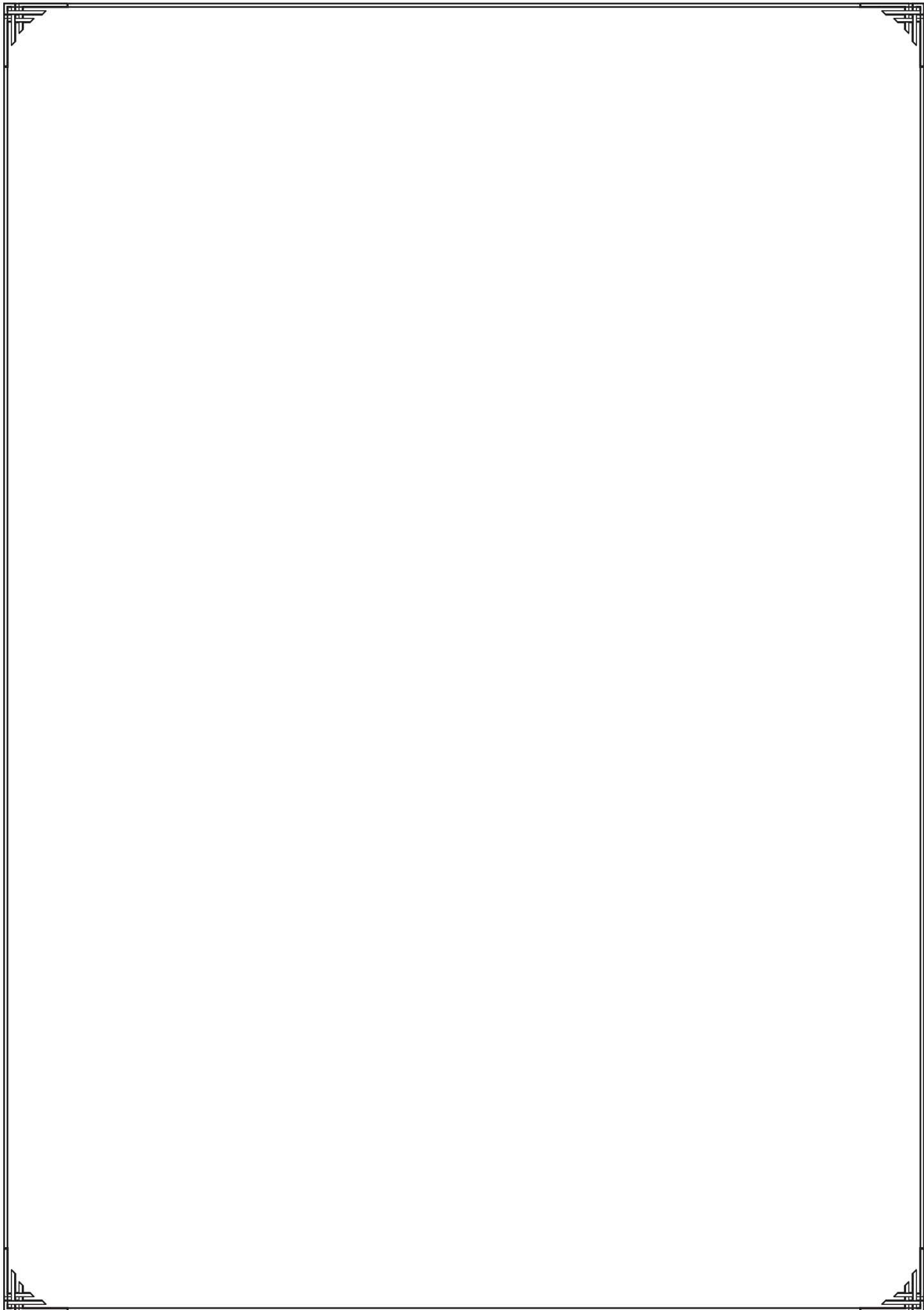

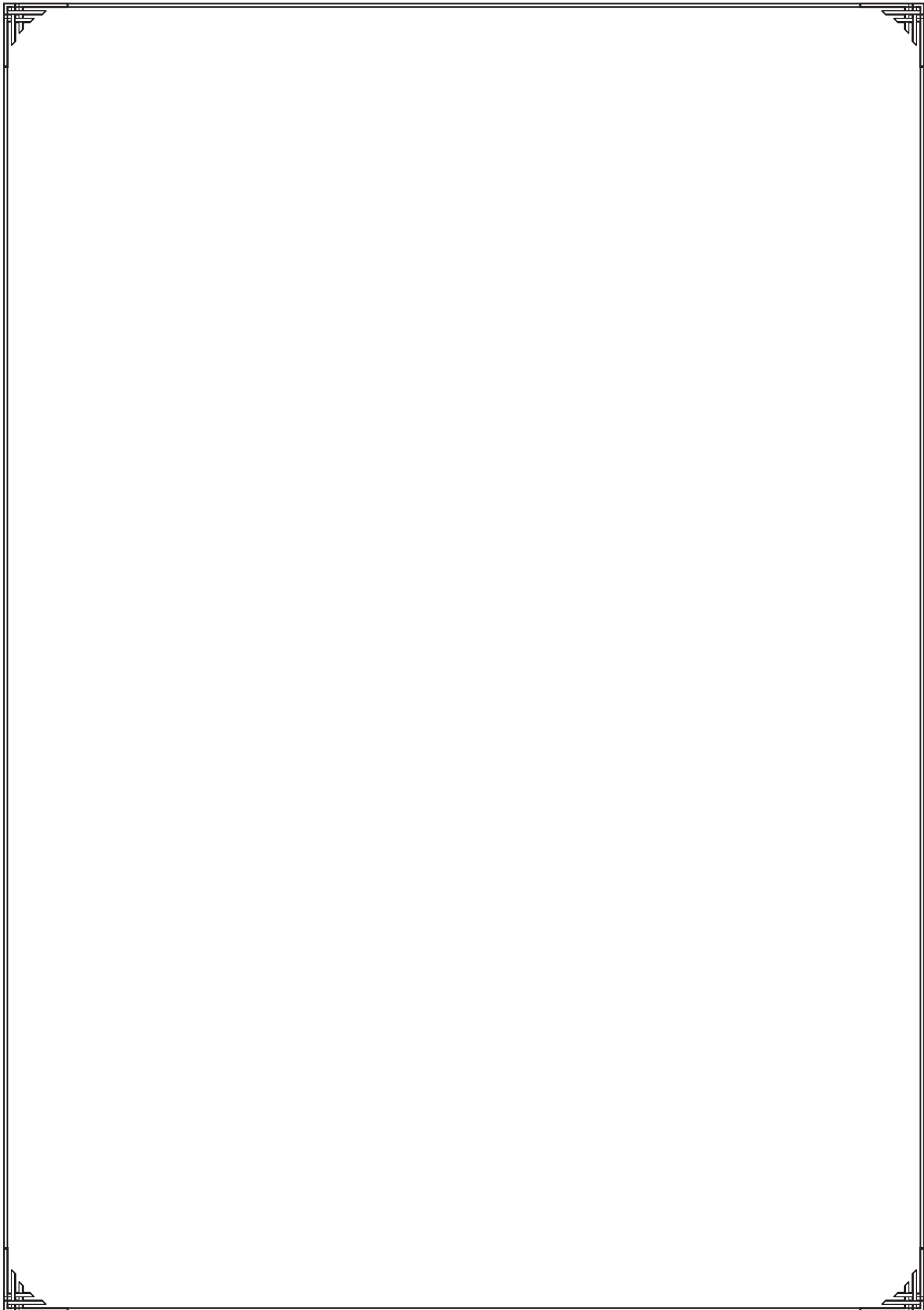

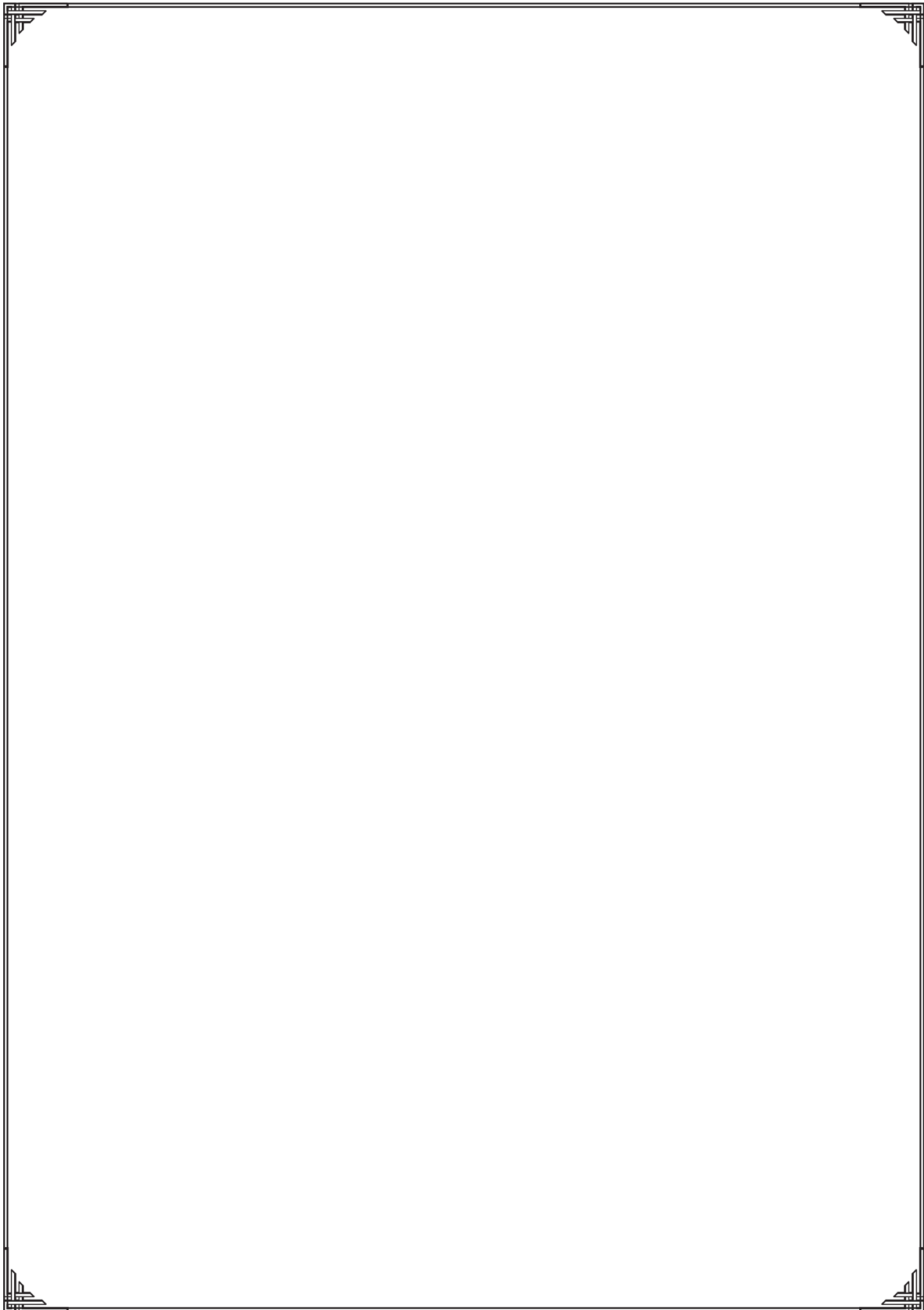

Forged Balusters



NB7-01
1000mm
Ø12mm



NB7-02
1000mm
Ø12mm



NB7-03
1000mm
Ø12mm



NB7-04
1000mm
Ø12mm



NB7-05
1000mm
Ø14mm



NB7-06
1000mm
Ø12mm



NB7-07
1000mm
Ø14mm



NB7-10
1000mm
Ø12mm



NB7-11
1000mm
Ø14mm



NB7-12
1000mm
Ø12mm



NB7-13
1000mm
Ø12mm



NB7-14
1000mm
x 140mm
Baluster is a
NB7-09



NB7-15
1000mm
x 140mm
Baluster is a
NB7-07



NB7-16
950mm

FORGED BALUSTERS

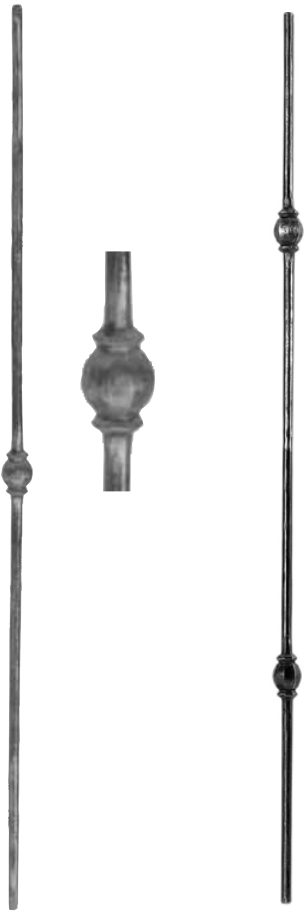

**INDIA
FB-60
496-C2
14 MM ROUND
450 OFF**

**IND.I.A
FB65
496-C2 X
14 MM ROUND
400 OFF**



**BIN 214
SHED 3
500 OFF**



**INDIA 500/1
12 MM ROUND
FBZ-130**

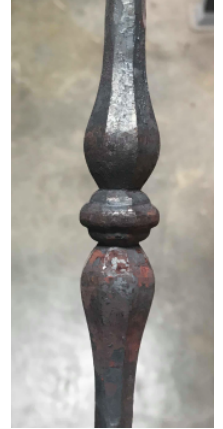

**INDIA 1770/1
12 MM ROUND
EX 9000/8**



**12 X 12 HAM
SHED 3 BIG BINS**

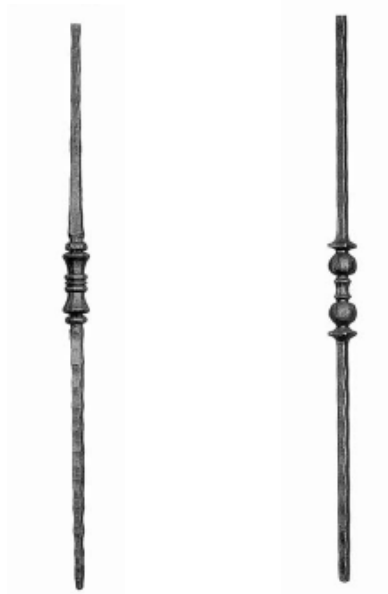

**FB-01 LY 12/01
SHED 14 PR44
2.6 KGS**



2.1 KGS

**LY12-06
FB-03**

**SHED 14
PR22
14 x 14 mm
40 mm diameter
ctr knobs**



**BELEIVE INDIA
NO LISTING
FBZ-120
12 MM ROUND**



CHECK 499/1 INDIA

PAGE 495
HOMO FABIA BOOK 2



FB-80
RIK FER
FORGED
ONE IN
WALKWAY

1.5 kgs
1000 x 150
ctr pattern is
16 x 8 mm
14 x 14 going
down to 6 mm
square

84 off ???



1770/7
EX 9000/14
FBZ140
1 KG



INDIA 490/2
12 X 12 MM
FB90



LUYI 14/09
12MM ROUND
1 MTR LONG

FBZ120
12 MM ROUND



LUYI 14-10
HT 1MTR
14 X 14



POB-19
900 X 150 MM
???? DISH

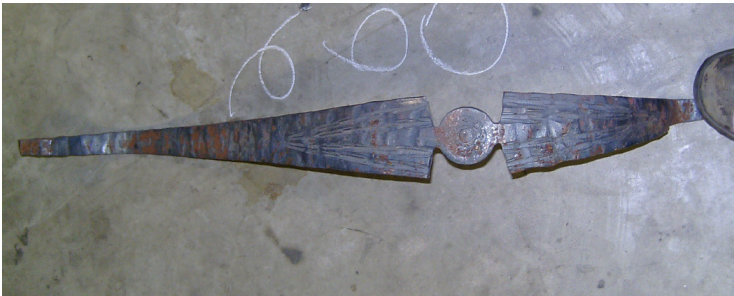
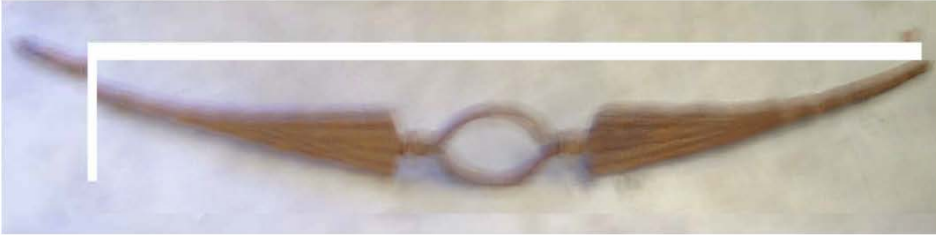

P



POB-13 900 X 90 MM LAVIN BAR
8 MM PLATE
DISH FLOOR TO MAX HEIGT

End Posts

All 1200mm long



NB16-01
 \square 25mm
NB16-02
 \square 30mm



NB16-03
 \square 25mm
NB16-04
 \square 30mm



NB16-05
 \square 25mm
NB16-06
 \square 32mm



NB16-07
 \varnothing 30mm



NB16-08
 \square 25mm
NB16-09
 \square 30mm



NB16-10
 \varnothing 30mm



NB16-11
 \square 30mm



NB16-12
 \square 25mm



NB16-13
 \square 25mm
NB16-14
 \square 30mm



NB16-15
 \square 30mm

Round
Knob



NB16-16
 \square 30mm

Square
Knob

Tube
60 x 60 mm



10
BAMBOO
END
POST

Art. 1207/1
H 1200 mm
L 85 mm



Art. 112/9
Φ 30 x 30 mm
H 1200 mm



H 1200 mm
Cod.art./Art.no.
113/5

113/6

BAMBOO
END
POST

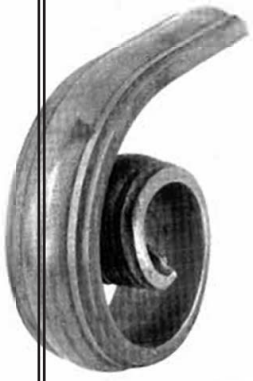

Top Rails

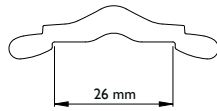
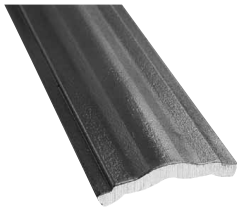

NB17-01
44 x 11 x 3 mtrs

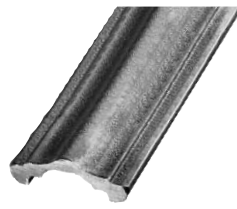

56 X 21 mm
NB17-60 - 2.9 mtrs
NB17-65 - 5.8 mtrs



TOP RAIL	L 2900mm	L 5800mm
	<i>PART NUMBER</i>	<i>PART NUMBER.</i>
50 X 12 mm	NB17-02	NB17-02A
60 X 20mm	NB17-02B	NB17-02C

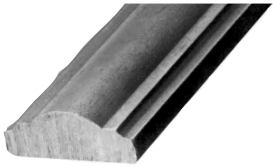

TOP RAIL SECTION	L 2900mm	L 5800 mm
50 X 15 mm	NB17-04	NB17-05
60 X 15 mm	NB17-06	NB17-07

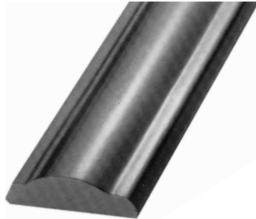

NB17-70
58 X 16 mm
4 mtrs Long

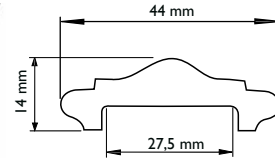

NB17-80
44 X 14 mm
3 mtrs Long

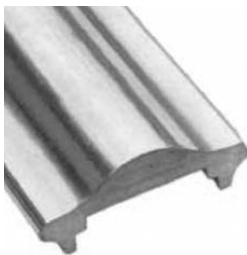

NB17-07
Brass Top Rail
Polished
58 x 22mm
2mtrs long

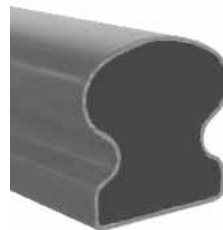

NB17-08
Steel Ladies
Waist Tube
55H x 50W x
1.5mm 6mtrs
long

TOP RAIL ENDS AND TURNS

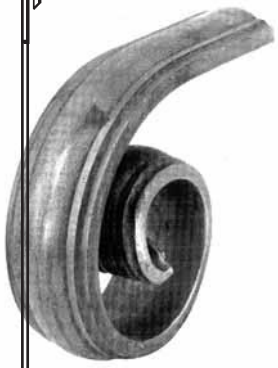

RAIL END [A]



RAIL END [B]



RAIL END [C]



RAIL END [D]

TOP RAIL CODE	RAIL END [A]	RAIL END [B]	RAIL END [C]	RAIL END [D]
NB17-60,65				
NB17-02	NB17-10	NB17-12	NB17-14	NB17-17
NB17-04,05	NB17-09	NB17-11	NB17-13	NB17-16
NB17-06,07				
NB17-70				



NB17-35
Suits NB17-06,07
325 mm inside
radius



NB17-40
Suits NB17-06,07
325 mm inside radius

TOP RAIL INFILLS AND RINGS

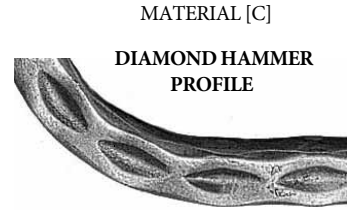
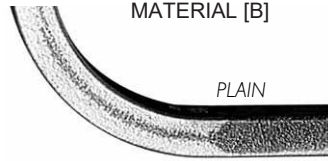
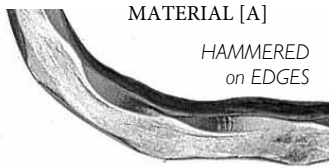

SIZE mm	MATERIAL B 12 x 6 mm	MATERIAL A 12 X 6 mm	MATERIAL B 12 X 12 mm	MATERIAL A 12 X 12 mm	MATERIAL A 14 X 6 mm	MATERIAL B 20 X 3 mm	8 mm Round bar mm	20 x 6 mm
Ø 80							NB17-18A	
Ø 100	NB17-19					NB17-40	NB17-19A	
Ø 105								
Ø 110								
Ø 115	NB17-21							
Ø 120	NB17-22	NB17-24A				NB17-45		
Ø 130	NB17-23A							



NB 17-25
190 x 100 mm
12 x 12 mm
Material A
NB17-26
12 x 12 mm



NB 17-27
100 mm diameter
12 x 6 mm

NB17-27A
115 mm Diameter
12 x 6 mm

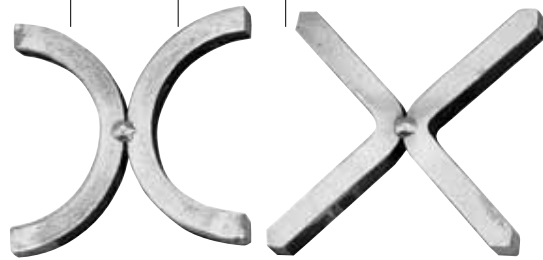

NB17-28
12 X 12 mm
100 X 100 mm

NB17-29
12 X 12 mm
100 X 100 mm



NB17-18
180 x 95mm
14mm

**GRAB RAIL
MOUNTING
BRACKET**
105mm wall to
centre of upright



NB17-30
560 x 80mm
Ø12mm

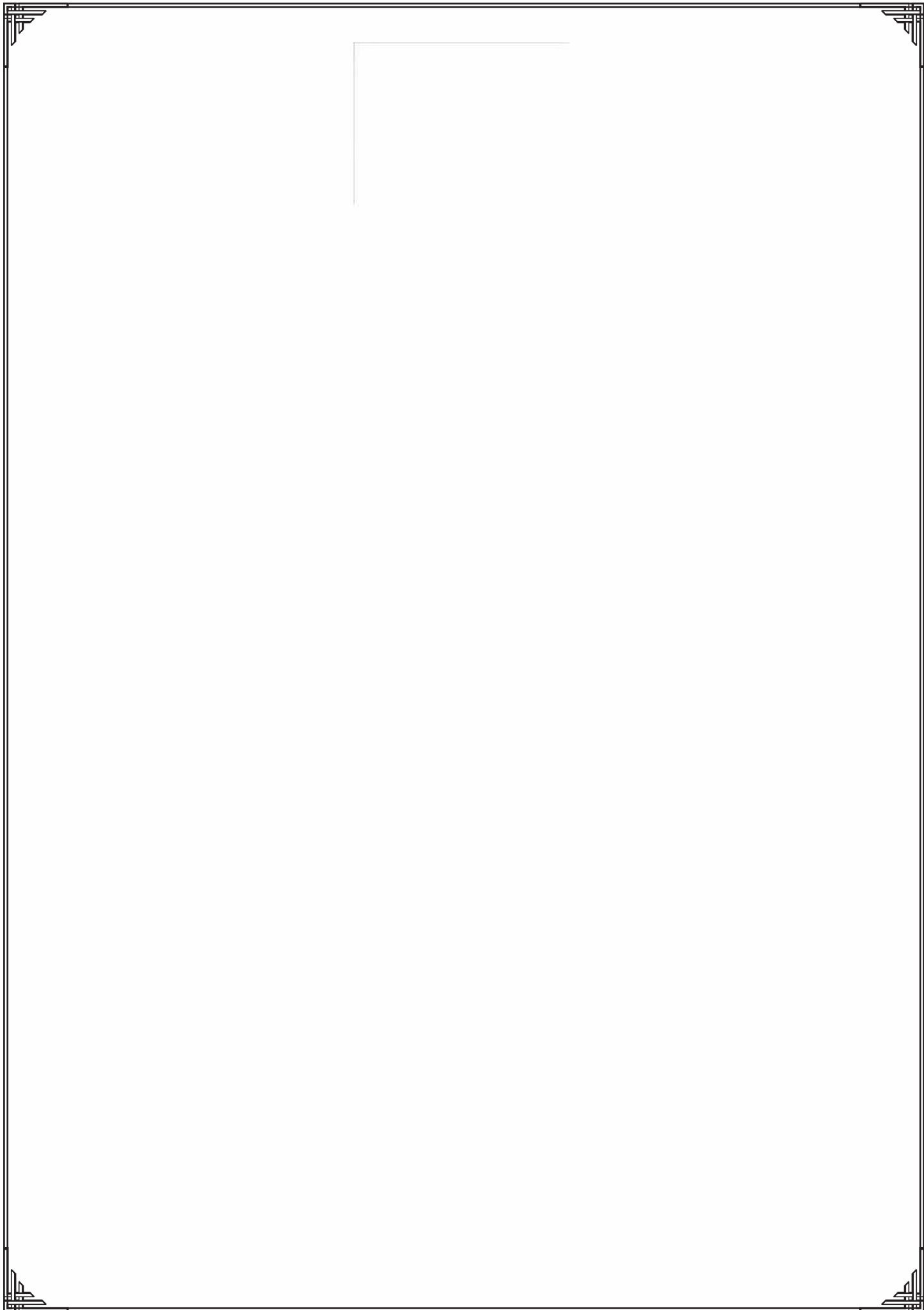

<i>Dimensions</i>		L 3000 mm	L 5800 mm
Φ 16 x 16 x 1.6 mm		NB18-01	NB 18-01A
Φ 20 x 20 x 1.6 mm		NB18-02	NB 18-02A
Φ 25 x 25x 2 mm		NB18-03	NB18-03A
Φ 30 x 30 x 2 mm		NB18-04	NB18-04A
Φ 40 x 40 x 2 mm		NB 18-07	NB 18-07A
Φ 50 x 50 x 2 mm		NB 18-08	NB18-08A
Φ 75 x 75 x 3 mm		NB18-10	NB18-10A
Φ 100 x 100 x 3 mm		NB18-11	NB18-11A
Φ			
Φ			
Φ			
Φ			
Φ			
Φ			

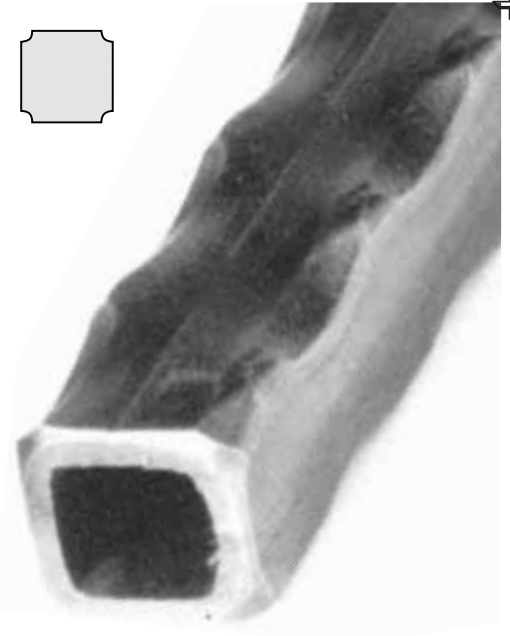

<i>Dimensions</i>		L 3000 mm	L 5800 mm
∕ 40 x 20 x2.5 mm	NIL STOCK	BOTH LENGHTS	NB18-60A
∕ 50 x 25 mm		NB18-09	NB18-09A
∕ 50 x 30 mm			NB18-09E
∕ 75 x 35 x2.5 mm			NB18-09F
∕ 100 x 40 mm			NB 18-09G
∕ 100 x 50 mm			NB18-11
∕			
∕			
∕			
∕			
∕			

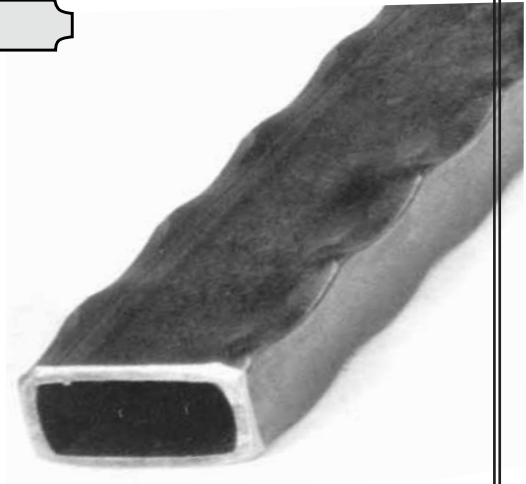

<i>Dimensions</i>	L 3000 mm	L 5800mm
∕ 12 x 6 mm		
∕ 25 x 8 mm		
∕ 30 x 8 mm		
∕ 40 x 8mm		
∕ 50 x 8 mm		
∕ 50 x 12 mm		
∕		
∕		
∕		

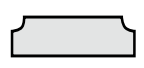

HAMMERED SECTIONS

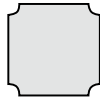

HAMMERED ON THE 4 CORNERS	L 3000 mm	L 5800 mm
⌀ 12 x 12 mm	NB18-17	
⌀ 14 x 14 mm	NB18-17A	
⌀ 16 x 16 mm	NB18-18	
⌀ 20 x 20 mm	NB18-19	
⌀ 24 x 24 mm	NB18-20	
⌀ 32 x 32 mm		NB18-20A
⌀		
⌀		

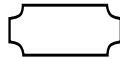

HAMMERED ON THE 4 CORNERS	L 3000 mm	L 5800mm
⌀ 12 x 6 mm		
⌀		
⌀		
⌀		
⌀		
⌀		



CROSS HAMMERED ON 4 SIDES	L 3000 mm	L mm
⌀ 12 x 12 mm	NB18-27	
⌀ 14 x 14 mm	NB18-27-14	
⌀ 16 x 16 mm	NB18-28	
⌀		
⌀		
⌀		



	L 3000 mm	L mm
⌀		
⌀		
⌀		
⌀		
⌀		
⌀		

HAMMERED PRODUCTS

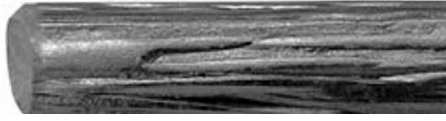

VINE BAR	L 3000 mm	L mm
<input type="checkbox"/> 6 mm Round Bar		
<input type="checkbox"/> 10 mm Round Bar		
<input type="checkbox"/> 12mm Round Bar		
<input type="checkbox"/> 20 mm Round Bar		
<input type="checkbox"/>		
<input type="checkbox"/>		

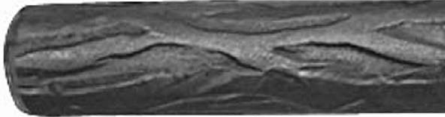

TREE BARK ROUND BAR	L 3000 mm	L mm
<input type="checkbox"/>		
<input type="checkbox"/>		
<input type="checkbox"/> 12mm Round Bar		
<input type="checkbox"/>		
<input type="checkbox"/>		
<input type="checkbox"/>		



TEXTURED ROUND BAR	L 3000 mm	L mm
<input type="checkbox"/> 10 mm Round Bar	NB18-80	
<input type="checkbox"/> 12 mm Round Bar	NB18-82	
<input type="checkbox"/> 16 MM round Bar	NB18-84	
<input type="checkbox"/> 20 mm Round Bar	NB18-86	
<input type="checkbox"/>		
<input type="checkbox"/>		



NB18-100
16 X 16 mm
3 mtrs long



TWISTED SECTIONS

TWISTED ROPE	L 3000 mm	L mm
∅ 12 mm	NB18-42	
∅ 16 mm	NB18-43	
∅		
∅		
∅		
∅		



TWISTED TUBE	L 3000 mm	L 6 MTRS
∅		
∅ 32mm Diameter		NB18-38
∅ 40 mm Diameter		NB18-39
∅ 50mm Diameter	NB18-40	
∅ 75mm Diameter		NB18-40
∅		



3000 mm LONG SECTION

NB18-50 ∅ 12 x 12 mm
 NB18-55 ∅ 16 x 16 mm
 □

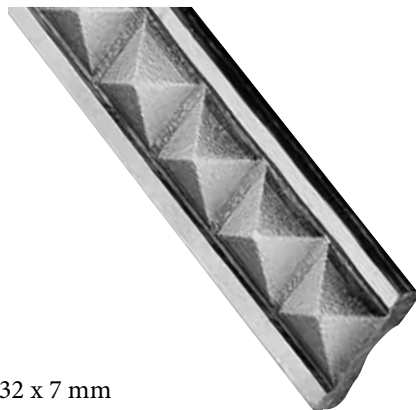

32 x 7 mm
 DEB-01
 3 mtrs long

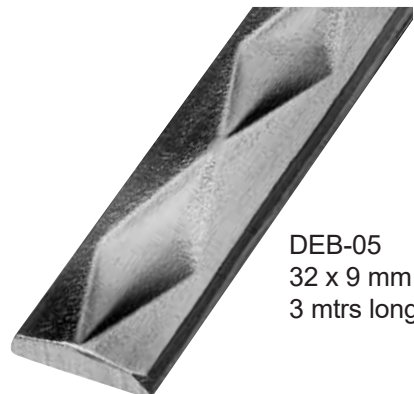

DEB-05
 32 x 9 mm
 3 mtrs long

PUNCHED & PRESSED BARS



NB18D-10
 14 X 14 Bar
 Holes 140 mm centers
 14 mm holes



NB18D-20
 14 X 14 Bar
 Holes 140 centers
 Holes at 45 degrees
 14 mm holes



14 mm Round bar
 Holes 140 mm centers
 14 mm Round holes
NB18D-30



NB18D-50
 14 X 14 Square
 Pitch is 125 mm
 Bar length is 2 Mtrs

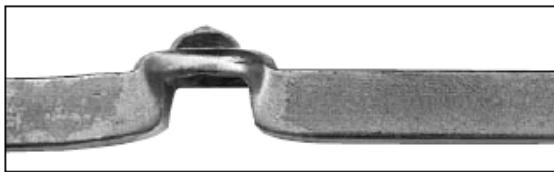

NB18C-75
 14x 14 mm
 Bar pitch 125 mm
 Bar length is 2 mtrs

Wrought Iron Panels



NB20-01
800 x 110mm
12mm



NB20-02
700 x 300mm
16 x 8mm



NB20-03
800 x 385mm
12mm



NB20-04
755 x 380mm
12mm



NB20-05
400 x 180mm
16 x 6mm



NB20-06
400 x 180mm
16 x 6mm

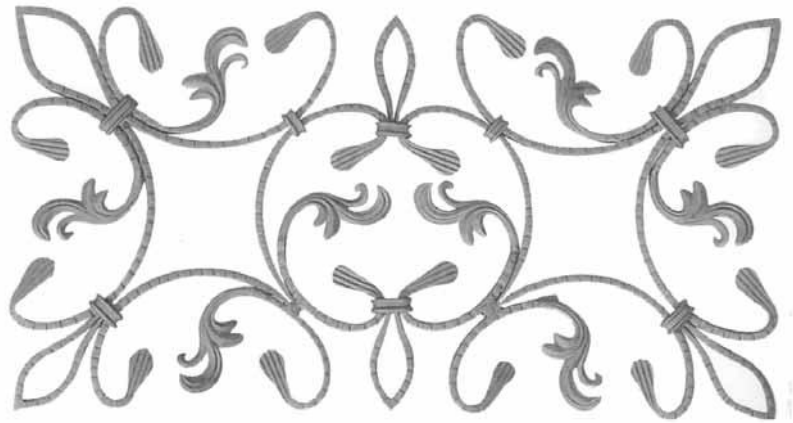

NB20-07
400 x 760mm
16 x 8mm

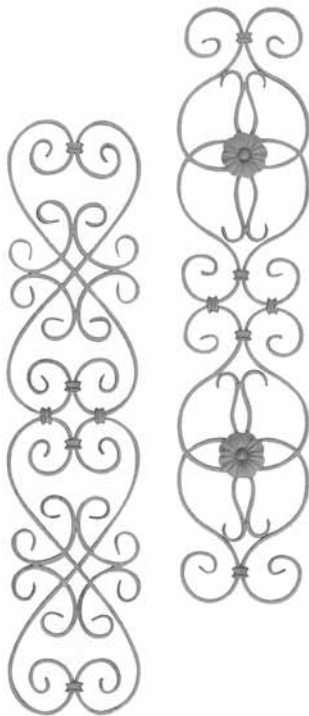

NB20-08
180 x 800mm
16 x 6mm

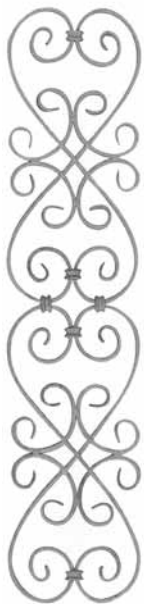

NB20-09
180 x 800mm
16 x 6mm



NB20-10
155 x 680mm
16 x 6mm



NB20-11
1155 x 590mm
16 x 8mm

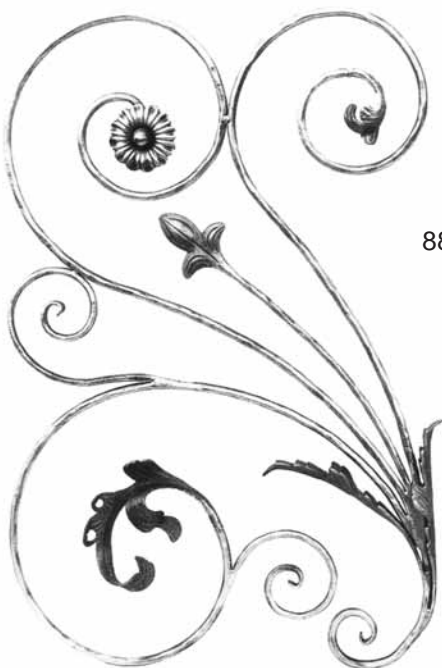
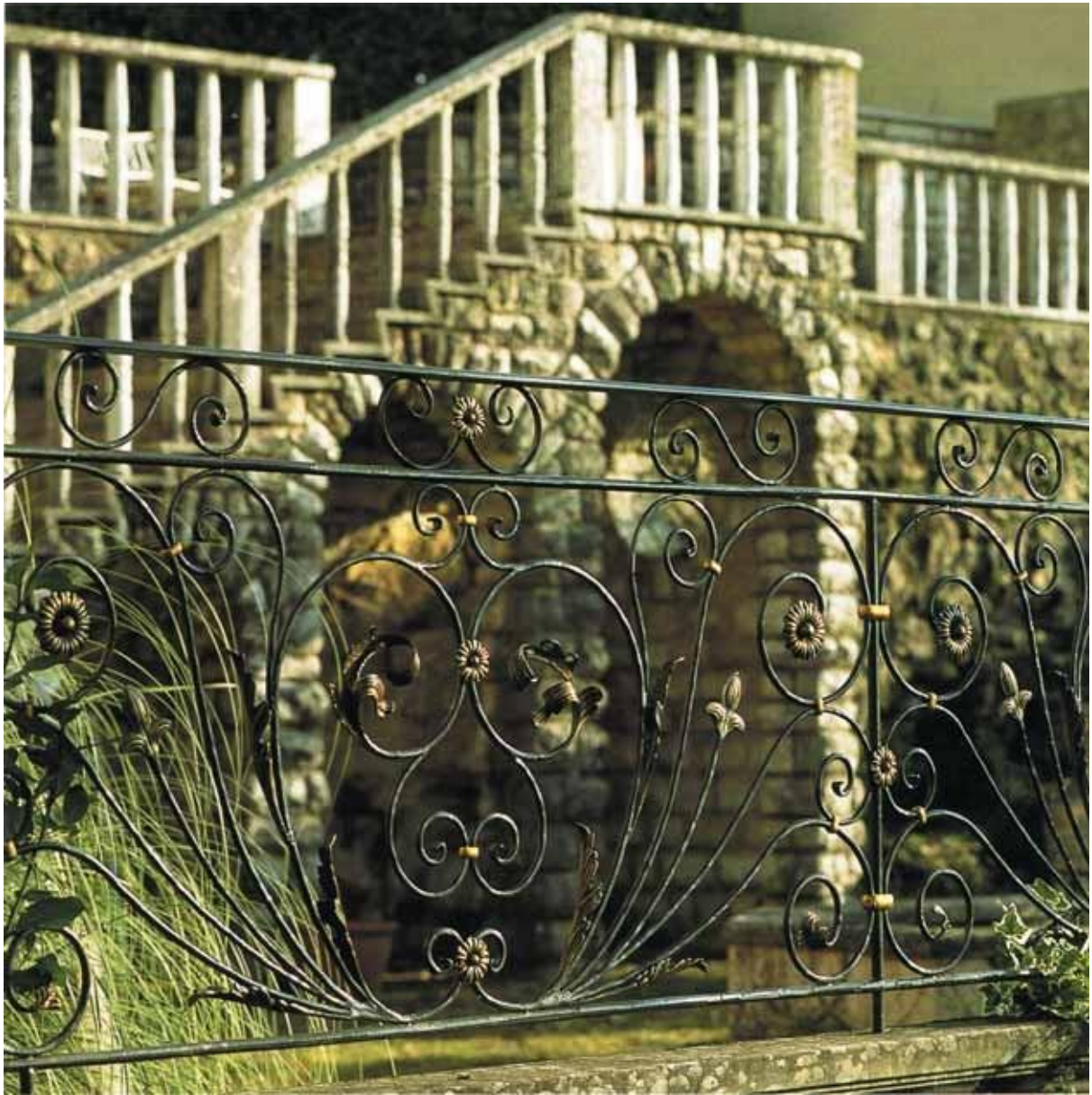

NB29-01
880 x 580mm
Ø 12mm
Left hand

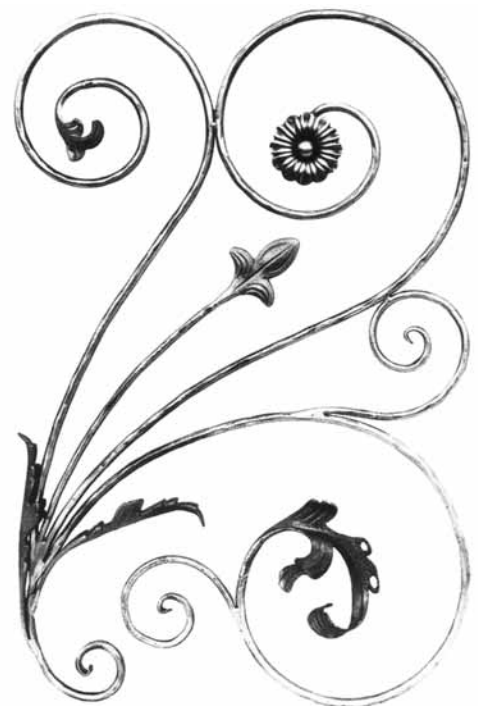

NB29-02
880 x 580mm
Ø 12mm
Right hand



Art.50/01

H.1060xL.740mm Φ 12mm



Art.50/02

H.1060xL.740mm Φ 12mm

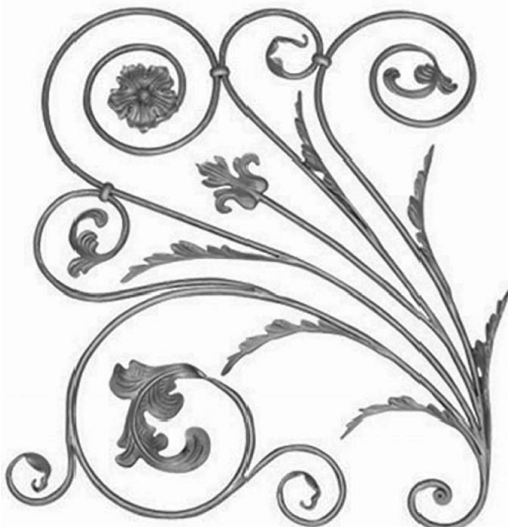

Art.50/03

H.880xL.800mm Φ 12mm



Art.50/04

H.880xL.800mm Φ 12mm



Art. 1647/5

□ 12 x 6 mm
H 250 mm
L 200 mm

INDIA PAGE 71
WISP110

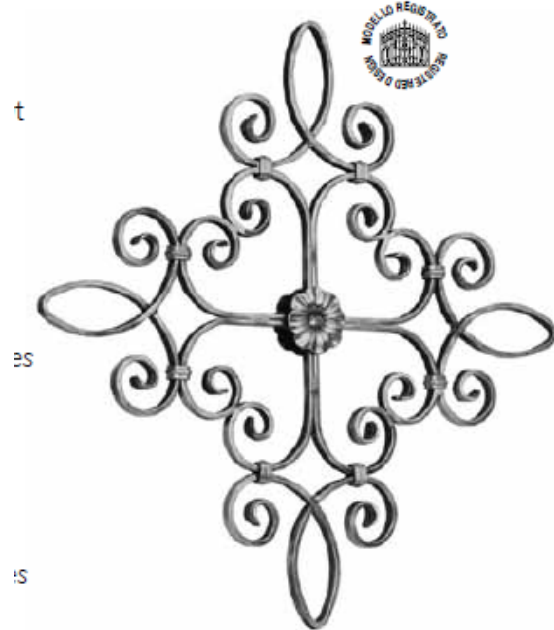

Art. 1647/I

□ 12 x 6 mm
H 610 mm
L 440 mm

WISP-82

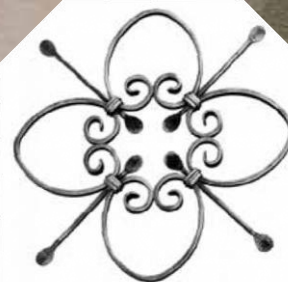

NB21-01
12 x 6mm
Ø 370mm

Collar Material



NB22-01
16 x 3mm
x 4 mtrs



NB22-02
20 x 3mm
x 4 mtrs



NB22-03
14 x 4mm
NB22-04
16 x 5mm
NB22-05
21 x 6mm
NB22-06
25 x 7mm
All x 4 mtrs

NB22-06A
30 X 8 mm
3 mtrs Long
NB22-06B
20 X 10 mm
3 MTRS Long
NB22-06C
25 X 12.5 mm
3 MTRS Long



NB22-07
14 x 4mm
x 4 mtrs



NB22-08
14 x 4mm
x 4 mtrs



NB22-07A
Suits 12 x 12 Bar
NB22-07B
Suits 24 x 12 Bar



NB22-08A
Suits 12 x 12 Bar
NB22-08B
Suits 24 x 12 Bar

Rosettes



NB22-13
250mm Round
⌀8mm



NB22-14
300mm Round
⌀8mm



NB22-15
389mm Round
10 x 5mm



NB22-16
230mm Round
12 x 6mm



NB22-17
295mm Round
⌀ 12mm



NB22-18
215 x 235mm
⌀8mm



NB22-19
290mm Round
⌀10 x 5mm



NB22-20
250 x 250mm
⌀12 x 6mm

Rosettes

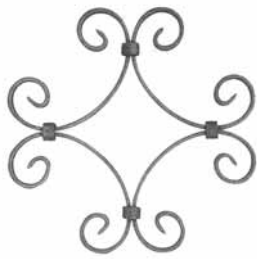

NB22-21
250 x 250mm
16 x 4mm

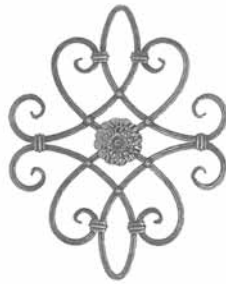

NB22-22
530 x 420mm
12mm

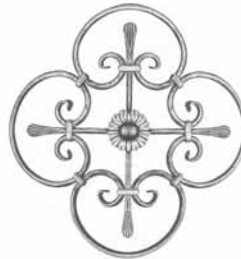

NB22-23
565 x 565mm
14mm

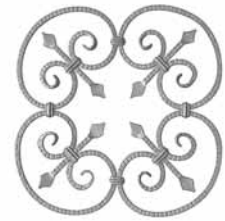

NB22-24
585 x 585mm
12mm



Art. 1667/2
14 x 8 mm
590 mm



Art. 1012/1
12 mm
560 mm



240 mm 315 mm
12 X 12 MM
240 X 240



RO27
300 X 300 X 12 X6
I THINK EARLY CHINNESE
RO-27

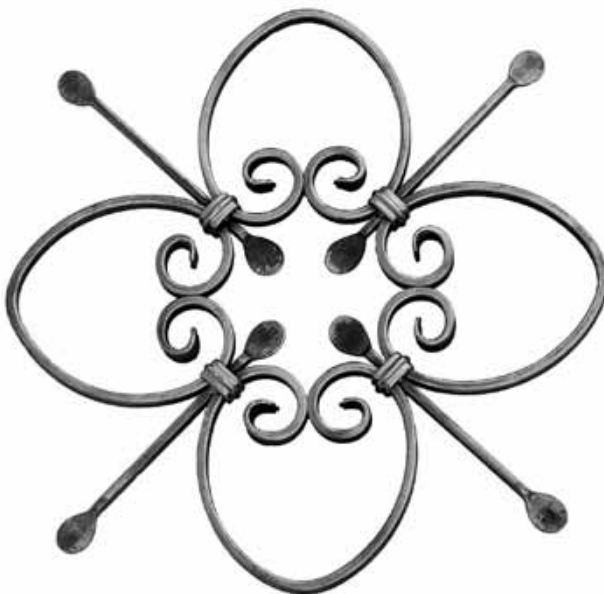

MEZ 37 INDIA 1009/2
12X 6 MM 370 MM X370



Art. 1667/1
14 x 8 mm
590 mm

3.9 KGS

INDIA PAGE 63

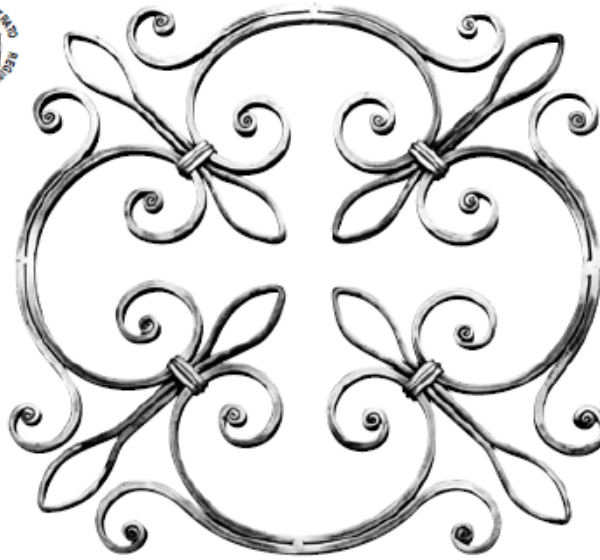

Art. 1667/2

□ 14 x 8 mm

Ø 590 mm



H 210 x L 210 mm

Art. 1665/14

Ø 14 x 14 mm

Art. 1665/15

Ø 16 x 16 mm

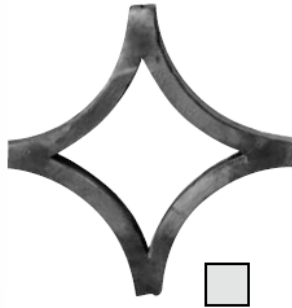

H 180 x L 180 mm

Art. 1665/10

Ø 14 x 14 mm

Art. 1665/11

Ø 16 x 16 mm



Articolo non vendibile in Spagna

Article not for sale in Spain

H 210 x L 210 mm

Art. 1665/12

Ø 14 x 14 mm

Art. 1665/13

Ø 16 x 16 mm



H 190 x L 190 mm

Art. 1665/8

Ø 14 x 14 mm

Art. 1665/9

Ø 16 x 16 mm



INDIA PAGE 64



WISP-84

s



Art. 1647/2
Ø 12 x 6 mm
H 500 mm
L 200 mm



?????????

Art. 116/A/4
2 lati / 2 sides

Art. 1647/3
Ø 12 x 6 mm
H 500 mm
L 200 mm



Ornamental Steel Snap-Ons



NB23-01
445 x 205mm
12 x 6mm



NB23-02
345 x 200mm
12 x 6mm



NB23-03
380 x 175mm
12 x 6mm

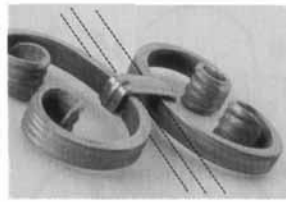

NB23-05
95 x 95mm
12 x 6mm

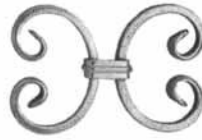

NB23-04
145 x 95mm
12 x 6mm



NB23-06
250 x 220mm
12 x 6mm



NB23-07
380 x 230mm
12 x 6mm



Decorative Chain

In bright steel



NB23-08
40mm Rings
5 x 5mm



NB23-09
55 x 15mm
5 x 5mm



NB23-10
40 x 12mm
3.5 x 3.5mm



NB23-11
28 x 9mm
3.8 x 3.8mm

Forged Ornaments



NB24-01
67 X 40 MM
12.5 RD HOLE
NB24-02
67 X 40 MM
16.5 RD HOLE

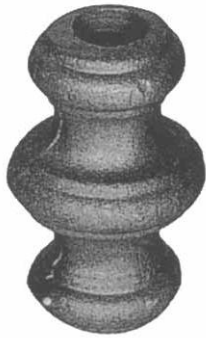

67 X 45 MM
NB24-02E
12.5 MM
SQUARE HOLE
NB24-02F
67 X 45 MM
14.5 MM
SQUARE HOLE

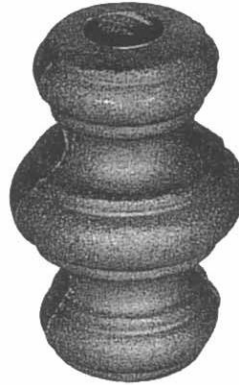

NB24-03
80 X 50 MM
16.5 MM
ROUND HOLE
NB24-03A
80 X 50 MM
16.5 MM
SQUARE HOLE
NB24-04
80X 50 MM
20.5 MM
ROUND HOLE



NB24-04G
68 H X 65 MM
20 .5 MM
SQUARE
HOLE



NB24-04F
80 X 65 mm
20.5 SQ Hole



NB24-04J
1 .6 MM TUBE
65 MMH X 30
MM DIAMETER
13 MM ROUND
HOLE



125 H X 42 DIA
NB24-05
12.5 MM
ROUND HOLE
NB24-06
16.5MM
ROUND HOLE
NB24-06B



120 H X 28 DIA
NB24-07
0 12.5 Hole
NB24-08
0 16.5 Hole



64 H X 28 DIA
NB24-09
0 12.5 Hole
NB24-10
0 16.5 Hole



70 H X 42 DIA
NB24-10H
0 16.5 Hole
NB24-10J
16.5 SQ
HOLE

16.5MM
SQUARE
HOLE

NB24-06C
20.5 MM
SQUARE
HOLE

FORGED ORNAMENTS



68 H X 40 Square
NB24-11
 12.5 SQUARE HOLE



NB24-12
 12.5 ROUND HOLE

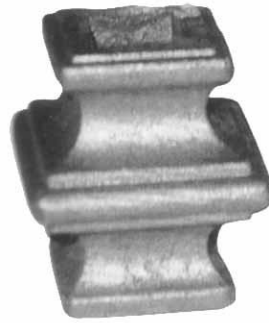

NB24-15
 48 X 48 X 44 H MM
 17 MM SQUARE
 HOLE



NB24-15B
 48 x 48 x 44 HIGH
 25 MM SQUARE
 HOLE

NB24-14
 40 X 40 X 45 mm HIGH
 13 mm SQUARE HOLE

NB24-15A
 48 X 48 X 44 H MM
 20.5 MM SQUARE
 HOLE

NB24-13
 16.5 SQUARE HOLE

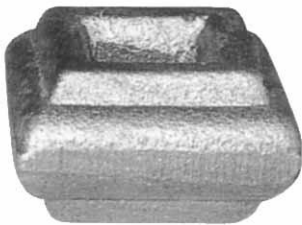

54 X 54 X 35 MM
NB24-16
 20 5 MM SQUARE
 HOLE
NB24-17
 26 MM SQUARE
 HOLE



38 X 38 X 22
NB24-27
 16.5 MM
 SQUARE HOLE



33 X 33 X 22 MM
NB24-26
 12.5 MM
 SQUARE HOLE



40 X 22H MM
NB24-18
 12.5 MM
 SQUARE HOLE



40 X 38 H MM
NB24-22
 12.5 MM
 ROUND HOLE
NB24-23
 16.5 MM
 ROUND HOLE



44 x 44H mm
NB24-23B
 20.5 mm Round
 hole



50 x 47 Hmm
NB24-23H
 16.5 MM
 SQUARE HOLE
NB24-23J
 20.5 MM
 ROUND HOLE

ROUND HOLE
NB24-20
 16.5 MM
 SQUARE HOLE
NB24-21
 16.5 MM
 ROUND HOLE



SOLID BUSHES



Art. 37/01
H.140xΦ33mm
Φ16-18mm



Art. 37/02
H.140xΦ28mm
Φ12-14mm



Art. 37/03
H 70xL.30mm
Φ 12-14mm



NB 32-06A
100X 45 X 16 Q
BASE



Art. 37/05
H.80xL.34mm
□14-16mm



Art. 37/06
H.140xL.34mm
□20mm



Art. 37/07
H.140xL.30mm
□16mm



Art. 37/08
H.140xL.26mm
□12mm



Art. 37/09
H.160xL.25mm
□14mm



Art. 37/10
H.80xL.35mm
□14mm



Art. 37/11
H.130xL.25mm
□14mm



Art. 37/13
H.140xL.24mm
Φ12mm



Art. 37/18
H.138xL.36mm
Φ14mm



Art. 37/19
H.160xL.26mm
□12mm

Mounting Plates & Bases

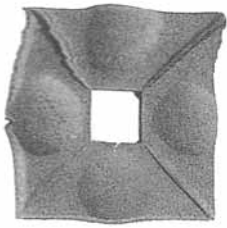

NB25-01
110 x 110 x 10mm
⌀ 26.5mm

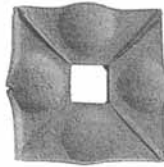

NB25-02
90 x 90 x 8mm
⌀ 21mm

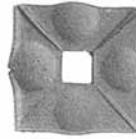

NB25-03
70 x 70 x 8mm
⌀ 16.5mm



NB25-04
50 x 50 x 6mm
⌀ 12.5mm



NB25-05
100 x 100 x 10mm



100 x 100 x 10mm
NB25-06
⌀ 26mm
NB25-07
⌀ 31mm

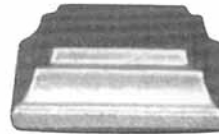

Base 100 x 100mm
NB25-08 no hole

NB25-09 ⌀ 40.5mm

NB25-10 ⌀ 51mm

Base 80 x 80mm

NB25-11 no hole

NB25-12 ⌀ 30.5mm

NB25-13 ⌀ 35.5mm

NB25-14 ⌀ 40.5mm

Base 60 x 60mm

NB25-15 no hole

NB25-16 ⌀ 25.5mm

NB25-17 ⌀ 30.5mm

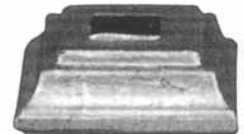

Base 50 x 50mm

NB25-18 no hole

Base 40 x 40mm

NB25-19 no hole

Base 35 x 35mm

NB25-20 no hole



Base 80mm round

NB25-21 no hole

NB25-22 ⌀ 30.5mm

NB25-23 ⌀ 35.5mm

NB25-24 ⌀ 40.5mm

Base 60mm round

NB25-25 no hole

NB25-26 ⌀ 30.5mm



Base 50mm round

NB25-27 no hole

Base 40mm round

NB25-28 no hole

Base 30mm round

NB25-29 no hole



NB25-30

100mm ⌀ x 5mm

⌀ 18mm centre



NB25-31
120 x 50mm
⌀ 4mm



NB25-32
145 x 60mm
⌀ 4mm



NB25-33
200 x 85mm
⌀ 4mm



NB25-34
280 x 120mm
⌀ 5mm



NB25A-05
143 X 143 X 5 MM
14 MM HIGH
9MM HOLE
NB25A-10
200 X 200 X 5M
19 MM HIGH
9 MM HOLE



NB25A-15
414 MM DIAMETER X 4MM
44 MMHIGH
9MM HOLE

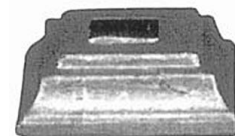

60 X 60 X 20 X 20 HOLE
ART 9-24
MEZ 3



art 46-12
87 long x 48 wide x26
high
12.5 x 53 mm slot
our code MPB-73
70 IN STOCK
MEZ 3

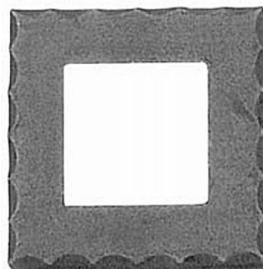

100 X 100 X 30 HIGH X 52
X 52 MM HOLE
ART 9C-18
MEZ3

Spear Tops



NB26-01
165 x 60mm
Ø 24mm



NB26-02
185 x 70mm
Ø 27mm



NB26-02A
212 x 80 mm
30mm Base



NB26-03
124 x 65mm
Ø 30mm



NB26-04
120 x 35mm
Ø 30mm



NB26-05
150 x 42mm
Ø 34mm



NB26-06
155 x 70mm
Ø 17mm



NB26-07
155 x 65mm
Ø 16mm



NB26-08
130 x 70 x 20mm
NB26-09
160 x 85 x 27mm

NB26-09A
200 X 110mm
33 mm base



NB 26-45
135 X 65 mm
25 mm BASE



NB26-50
185 X 55mm
32 mm Round
base
6mm Thick
above top
knob



NB26-55
293 X 75 mm
Base 26 mm
square



NB26-65
H.120mm
W-110mm
Cast Steel

Art. 2/06
H.120mm
L.55mm
Ø 20mm



mex 3 near
scrolls



Art. 3A/06
H.135mm
L.60mm
Ø 12mm

mez 3 near
scrolls



Art. 3B/08
H.100mm
L.45mm
Ø 12mm

Forged Spears



NB26-12
150 x 12mm \varnothing
NB26-13
150 x 16mm \varnothing



NB26-14
150 x 12mm \varnothing
NB26-15
150 x 16mm \varnothing



NB26-16
200 x 12mm \varnothing
NB26-17
 \varnothing



NB26-18
205 x 65mm
35mm \varnothing



NB26-19
130 x 33mm
x Base30mm
Round point



NB26-20
135 x 30mm
x Base30mm
Square point

NB 26-18B
220 high
40 mm
BASE



NB26-101
H.150mm
12 X 12mm
Base



NB26A-30
H.165X 55mm
25mmRound
Base



NB26A-50
H.185 X 65 mm
40mm Round Base



NB26A-55
H.130 X 47 mm
33mm Round Base



Art. 1855/9
 \varnothing 35 mm
H 200 mm

220 HIGH
40 BASE
PAGE 395
INDIA



NB26A-35
H.152mm
26mmRound
Base



NB26A-40
H.180 mm
43mm Round
Base



NB26A-45
H.200 mm
41 mm Round
Base



Art. 126/17
 \varnothing 25 x 25 mm
H 290 mm

INDIA PAGE
396

FORGED ENDS & CAPS



NB26-21
145 x 22
x 25mm □
NB26-22
145 x 30
x 30mm □



NB26-23
155 x 35
x 35mm □
NB26-24
155 x 40
x 40mm □



NB26-24B
150mm High
40 X40 mm
Base



NB26-25
130 x 30
x 30mm □
NB26-26
220 x 40
x 40mm □



NB26-27
210 x 30
x 30mm □
NB26-28
210 x 40
x 40mm □



NB26-29
300 x 25
x 25mm □
NB26-30
145 x 40
x 40mm □



NB26-31
320 x 40
x 40mm □



NB26-45
105H X
60X60mm
Base



NB26-48
75 mm HIGH
40 X40 mm
Base



NB26-10
85mm High X
40 X 40 Square



NB26-11
85mm HIGH
40 mm Round



NB26-57
79mm HIGH
Base fits 35mm
RHS



NB26-60
75mm High
Bease fits 40 x
40 mm R.H.S



NB26C-95
FOLDED AND
WELDED CAP TO GO
OVER
50 X 50 SECTION
CAP 70 MM HIGH

Iron Forged Hammered Scrolls



NB27-01
250 x 75mm



NB27-02
335 x 80mm



NB27-03
135 x 90mm



NB27-04
165 x 105mm



NB27-05
330 x 170mm



NB27-06
390 x 150mm



NB27-07
105 x 70mm



NB27-08
125 x 80mm



NB27-09
140 x 90mm



NB27-10
200 x 105mm



NB27-11
260 x 120mm



NB27-12
295 x 175mm



NB27-13
150 x 70mm



NB27-14
220 x 100mm



NB27-15
250 x 115mm



NB27-16
300 x 100mm



NB27-17
320 x 120mm



NB27-18
400 x 125mm

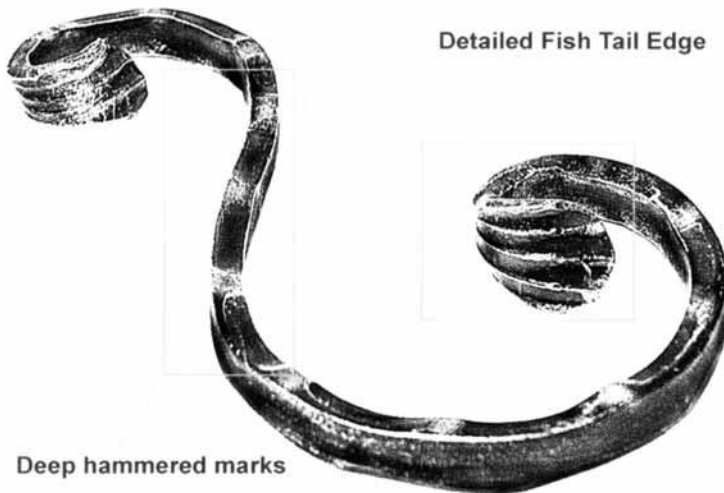

Detailed Fish Tail Edge

Deep hammered marks

Steel Scrolls

MATERIAL 12 X 6MM UNLESS NOTED



NB28-01
150 x 70mm
NB28-02
225 x 100mm
NB28-03
300 x 120mm



NB28-04
115 x 95mm



NB28-05
95 x 60mm
NB28-06
105 x 70mm
NB28-07
115 x 75mm
NB28-08
120 x 70mm



NB28-09
130 x 70mm
NB28-10
150 x 75mm
NB28-11
140 x 75mm
NB28-12
240 x 125mm



NB28-13
205 x 150mm
NB28-14
250 x 150mm



NB28-15L
200 x 125mm
NB28-15R
200 x 125mm

NB28-15A
150 X 60 MM



NB28-16
150 x 70mm
NB28-17
250 x 100mm
NB28-18
250 x 115mm
NB28-19
300 x 120mm
NB28-20
400 x 120mm
(12 x 12mm)



NB28-21
350 x 100mm
NB28-22
350 x 110mm
NB28-23
350 x 120mm
NB28-24
400 x 120mm
(12 x 12mm)



NB28-25
150 x 105mm



NB28-26
105 x 60mm
Tail left hand



NB28-27
105 x 60mm
Tail right hand



NB28-28
230 x 50mm

These four scrolls are edge notched

*The scrolls listed above are mainly our stock items.
We can custom make scrolls up to 50 x 12mm flat or 25 x 25mm solid.*

Hot Forged Scrolls with Curled Ends

MATERIAL 16 X 8MM FORGED BAR



NB28-29
160 x 100mm



NB28-30
125 x 80mm



NB28-31
115 x 65mm



Art. 1144/3
 ⌀ 12 x 12 mm
 H 350 mm
 L 145 mm



PSS-80
 590
 GRAMS

Art. 641/7
 ⌀ 12 x 6 mm
 H 360 mm
 L 120 mm
 80 mm small end

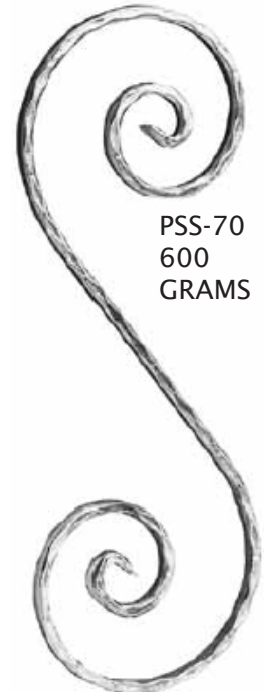

PSS-70
 600
 GRAMS

Art. 641/8
 ⌀ 12 x 6 mm
 H 360 mm
 L 120 mm

PSS-98
 PSS-96
 DOUBLE UP



Art. 1144/6
 ⌀ 12 x 12 mm
 H 270 mm
 L 160 mm
 small end 100 level wide



Art. 1299/2
 ⌀ 12 x 6 mm
 H 140 mm
 L 140 mm

300 OFF ???

PSS-65
 300 grams
 MEX3 END
 BAY



H 210 mm	
L 130 mm	
Cod.art./Art.no.	
80/C/12	

PSS-22
 60 OFF ????
 SHED 3 MEZ END
 BAY



Art. 88/A/1
 ∅ 12 x 6 mm
 H 135 mm
 L 60 mm

SHED 14 PR64
 100 GRAMS
 250 OFF ????



PSS-92
 12 X 6 FLARED END
 90 LONG X 50 MM
 150 OFF ???
 100 GRAMS



Art. 88/P/2
 ∅ 14 x 8 mm
 H 160 mm
 L 80 mm
 90 OFF ???
 MEZ FLOOR
 SHED 3 END
 BAY
 300 GRAMS



Art. 1299/1
 ∅ 12 x 6 mm
 H 140 mm
 L 60 mm

PSS-63
 100 GRAMS

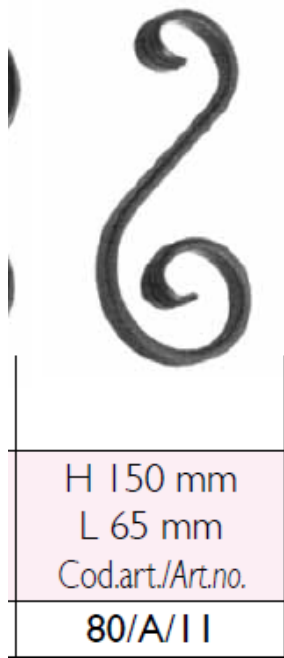

H 150 mm L 65 mm Cod.art./Art.no.
80/A/1

SMALL BINS
 SHED 3



H 110 mm L 60 mm Cod.art./Art.no.
80/A/3

MEX 3 END BAY
 CHECK TRATOR FLARE

AMOUNT
 WEIGHT



LY 18-07A
 PSS-90
 600 OFF ????
 140 X 75 MM
 12 X 6 MM
 210 GRAMS
 MEZ 38 AND 39
 SHED 3

INDIA PAGE 290
MEZ 37
SHED 3



Art. 497/1

Art. 1309/1
Ø 12 mm
H 450 mm
L 110 mm

MEZ 37
SHED 3



Art. 98/1

Art. 1309/5
H 450 mm
L 110 mm



Art. 6092/3
Φ 20 x 20 mm
H 370 mm
L 110 mm

INDIA PAGE 292

INDIA PAGE
290



NB35-01
Pattern baluster.
Ornament used
on straight bar is
a NB24-1

NB35-02
Balustrade made up of
NB24-1 centre
ornaments and bottom
& top ornaments using
NB24-22.
On stairs bottom & top
ornament is a NB24-24





NB36-01
Wrought iron panels
used with timber posts
and timber top rail



NB36-02

Components used are NB14-06 verticals, NB5-02 pattern, NB18-8 bottom rail with a NB28-29 support scroll.

Elite Gate Styles

MADE FROM STEEL AND ALUMINIUM MATERIAL



GS37-01



GS37-02

Elite Gate Styles

MADE FROM STEEL AND ALUMINIUM MATERIAL



GS38-01



GS38-02



GS38-03

Elite Gate Styles

MADE FROM STEEL AND ALUMINIUM MATERIAL



GS39-01



GS39-02

Elite Gate Styles

MADE FROM STEEL AND ALUMINIUM MATERIAL



GS40-01



GS40-02

Elite Gate Styles

MADE FROM STEEL AND ALUMINIUM MATERIAL



GS41-01

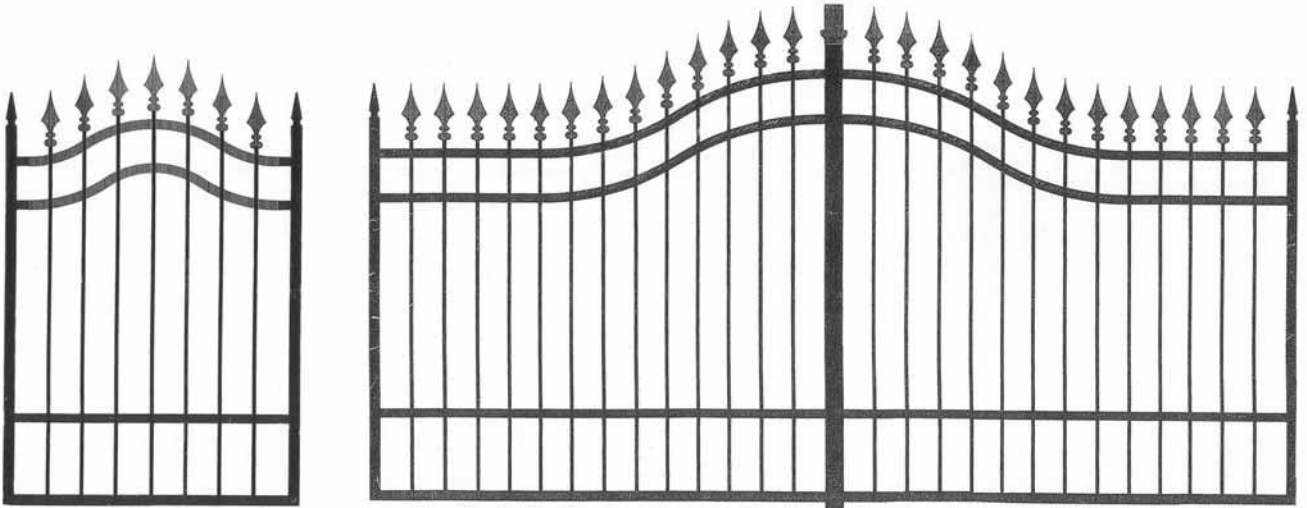

GS41-02

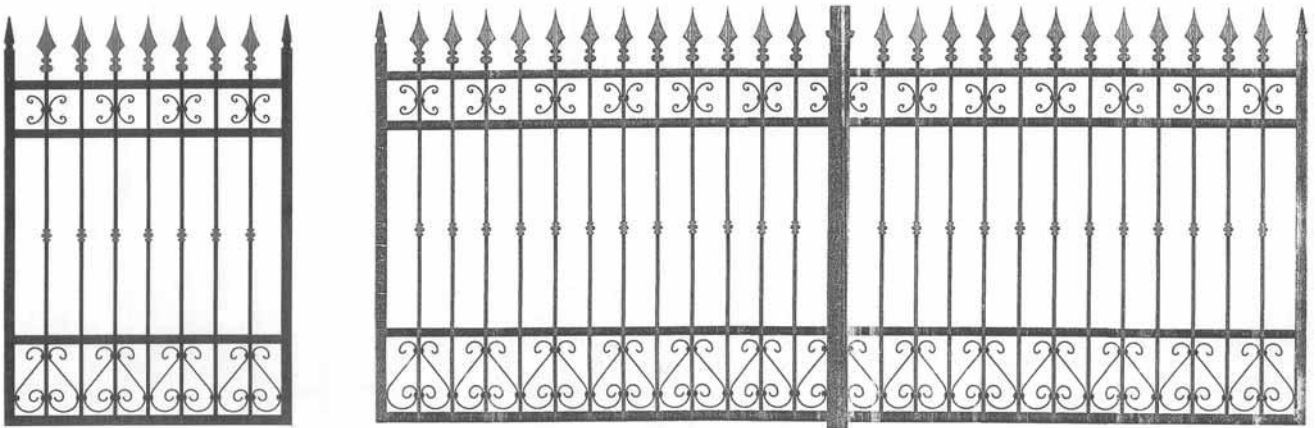

GS41-03

Elite Gate Styles

MADE FROM STEEL AND ALUMINIUM MATERIAL



GS42-01



GS42-02

Elite Gate Styles

MADE FROM STEEL AND ALUMINIUM MATERIAL

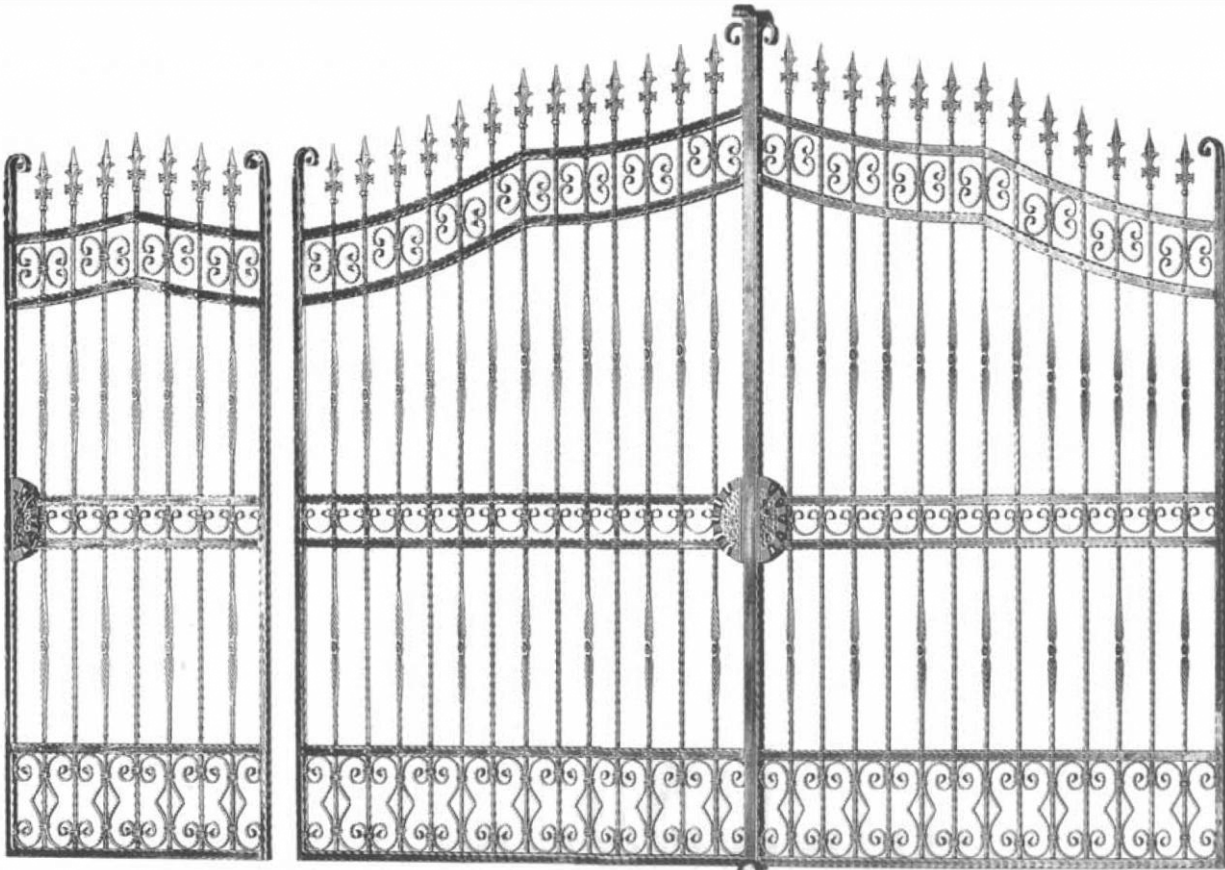

GS43-01



GS43-02

Elite Gate Styles

MADE FROM STEEL AND ALUMINIUM MATERIAL



GS44-01



GS44-02

Elite Gate Styles

MADE FROM STEEL AND ALUMINIUM MATERIAL



GS45-01



GS45-02

Wrought Iron Security floors & Panels

USING STANDARD MADE PANELS – ALL PATTERNS ARE MADE FROM 12 X 6MM FLAT BAR



NB46-01
Stork



NB46-02
Fish
680 x 340mm



NB46-03
Sailing Boat



NB46-04
Bird
530 x 520mm

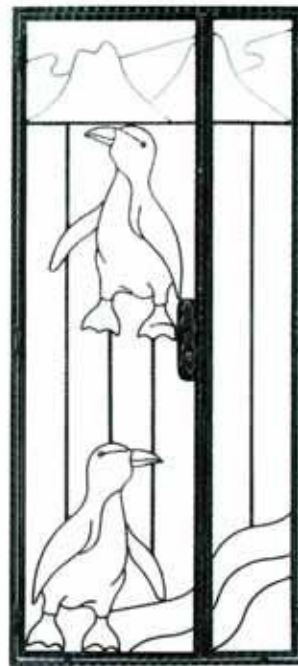

NB46-05
Penguin

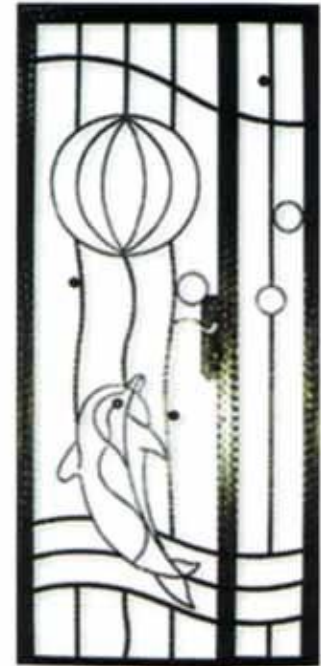

NB46-06
Dolphin
700 x 430mm



NB46-07
Dog



NB46-08
Dolphin
700 x 430mm

PART NUMBERS ARE FOR THE DESCRIPTION OF PATTERNS ONLY

Roses & Rose Leaves



NB47-01
60mm \varnothing
1.5mm



NB47-02
45mm \varnothing
1.5mm



NB47-03
30mm \varnothing
1.5mm



NB47-04
180mm x
4mm \varnothing



NB47-05
200mm x
4mm \varnothing



NB47-06
320mm x
6mm \varnothing



NB47-07
320mm x
6mm \varnothing



NB47-08
60 x 24mm x 0.8mm
NB47-09
70 x 35mm x 0.8mm
NB47-10
90 x 47mm x 0.8mm



NB47-11
260mm x
6mm \varnothing



NB47-12
260mm x
6mm \varnothing



NB47-13
320mm x
6mm \varnothing



NB47-14
320mm x
6mm \varnothing

Baskets



INDIA PAGE
374

- NB48-01**
12 x 12mm base
125 x 62mm
NB48-02
16 x 16mm base
142 x 70mm
NB48-03
20 x 20mm base
170 x 75mm
NB48-04
24 x 24mm base
190 x 110mm
NB48-05
30 x 30mm base
210 x 115mm

Pine Cones



- NB48-06**
12 x 12mm base
140 x 75mm
NB48-07
24 x 24mm base
190 x 105mm
NB48-08
30 x 30mm base
245 x 130mm

Onions



- NB48-09**
50mm diameter
6 strands of 4mm
NB48-10
70mm diameter
6 strands of 6mm
NB48-10A
70mm Diameter
4 strands of 6 x 6 mm

Baluster Knobs

Hot Rivets



- NB48-11**
50 x 6mm
NB48-12
50 x 8mm
NB48-13
50 x 10mm



- NB48-14**
45 x 30mm base Ø
NB48-15
50 x 45mm base Ø
NB48-16
70 x 55mm base Ø



- NB48-17**
100mm
Ø 50mm



- NB48-18**
90mm
Ø 50mm

Smooth Solid Balls



- NB48-19** 20mm Ø
NB48-20 25mm Ø
NB48-21 30mm Ø
NB48-22 40mm Ø

40 MM HOLLOW BALL
INDIA 1394/23
PAGE 383
MEZ 3 ????
AMOUNT ?????

- NB48-23** 50mm Ø
NB48-24 70mm Ø
NB48-25 90mm Ø
NB48-26 100mm Ø

Forged Balls with Diamond Surface



- NB48-27** 25mm Ø
NB48-28 30mm Ø
NB48-29 40mm Ø
NB48-30 50mm Ø

- NB48-31** 70mm Ø
NB48-32 90mm Ø
NB48-33 100mm Ø



Art. 171/40
15 x 15 mm

Art. 171/41
20 x 20 mm

due punte
two points

Art. 171/42
25 x 25 mm

BAMBOO LEAVES



BALUSTER KNOBS



NB 48-14
45H X 31mm base
NB48-15
55H X 42 mm base
NB48-16
73H x 55 mm base



NB48-17
100H X 48mm
base



NB48-18
90 H X 48mm
base



NB48-18A
80H x 28mm base
NB48-18B
100H X 50mm base

Sheet Metal Items



NB49-01
62 x 27 x 0.8mm
NB49-02
70 x 35 x 0.8mm
NB49-03
90 x 47 x 0.8mm



NB49-04
75 x 70mm
0.5mm



NB49-05
95 x 105mm
0.5mm



NB49-06
190 x 190mm
0.5mm



NB49-07
130 x 65 x 0.5mm
NB49-08
90 x 50 x 0.5mm



NB49-09
69 x 60 x 0.5mm



NB49-10
110 x 65 x 0.5mm



NB49-11
175 x 125 x 0.5mm

Candle ftishes

ALL 2MM MATERIAL

- NB49-12** 50mm
- NB49-13** 55mm
- NB49-14** 60mm
- NB49-15** 70mm
- NB49-16** 85mm
- NB49-17** 100mm
- NB49-18** 110mm
- NB49-19** 125mm
- NB49-20** 150mm

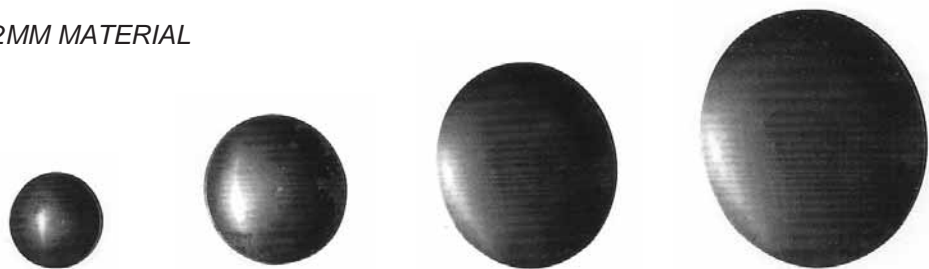

Candle Cups



NB49-21
22mm
NB49-22
26mm

Hot Stamped Flowers



NB50-01
65mm x
2mm thick



NB50-02
90mm x
2mm thick



NB50-03
60mm x
2mm thick



NB50-04
90mm x
3mm thick



NB50-05
90mm x 3mm thick
NB50-06
125mm x 5mm thick



NB50-07
90mm x 3mm thick
NB50-08
130mm x 4mm thick



NB50-09
90mm x 3mm thick
NB50-10
130mm x 4mm thick



NB50-11
50mm x
2.5mm thick



NB50-50
90mm x 4 mm



NB50-55
112mm x 4 mm



NB50-60
117 mm x 4 mm

Grapes & Leaves

3 Dimensional
Forged Grape
Bunch
NB50-12
170 x 90mm
NB50-13
200 x 150mm



3 Dimensional
Smooth Ball
Grape Bunch
NB50-14
150 x 100mm
NB50-15
200 x 140mm



NB50-16
80 x 80 x 3mm
NB50-17
125 x 118 x 3mm



NB50-18
6mm round
x 150mm



NB50-19
125 x 75mm
NB50-20
155 x 110mm



NB50-21
130 x 65mm x
0.5mm thick
pressed metal



NB50-22
90 x 50mm x
0.5mm thick
pressed metal



NB35-23
Grape vine
8mm \varnothing x 3mtr
NB35-24
12mm \varnothing x 3mtr

FORGED FLOWERS AND LEAVES



FORGED FLOWERS AND LEAVES



Stamped Leaves



109 x 42 x 3mm
NB51-01 As shown
NB51-02 Right hand



65 x 75 x 3mm
NB51-03 As shown
NB51-04 Right hand



110 x 85 x 3mm
NB51-05 As shown
NB51-06 Right hand



150 x 65 x 3mm
NB51-07 As shown
NB51-08 Right hand



45 x 30 x 2mm
NB51-09

Forged Leaves

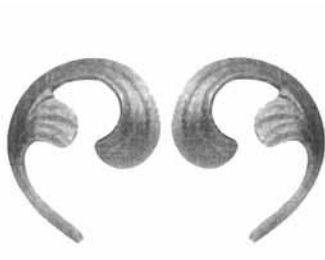

NB51-10
 100 x 80mm
 4mm thick



NB51-11
 100 x 80mm
 4mm thick



NB51-12
 100 x 110mm
 4mm thick



NB51-13
 100 x 110mm
 4mm thick



NB51-14
 130 x 120mm
 4mm thick



NB51-15
 130 x 120mm
 4mm thick



NB51-16
 200 x 170mm
 4mm thick



NB51-17
 200 x 170mm
 4mm thick



NB51-18
 150 x 80mm
 4mm thick



NB51-19
 240 x 105mm
 4mm thick



NB51-20
 80 x 65mm
 4mm thick



NB51-21
 80 x 65mm
 4mm thick



NB51-22
 130 x 55mm
 4mm thick



NB51-23
 130 x 55mm
 4mm thick



NB51-24
 150 x 140mm
 4mm thick



NB51-25
 150 x 140mm
 4mm thick



NB51-26
 160 x 135mm
 4mm thick



NB51-27
 160 x 135mm
 4mm thick



NB51-28
 160 x 150mm
 4mm thick



NB51-29
 160 x 150mm
 4mm thick



NB51-30
 105mm
 4mm thick

Gate Tops



NB52-01
900mm x 225mm
25 x 6mm



NB52-02
900mm x 300mm
20 x 6mm



NB52-03
900mm x 225mm
25 x 8mm



NB52-04
1300mm x 300mm
25 x 8mm

THESE ITEMS CAN BE MADE TO SUIT ARCH AND CUSTOM WAVE TOPS



NB52-05
900mm x 225mm



NB52-06
900mm x 225mm



NB52-07
900mm x 225mm



NB52-08
900mm x 225mm



NB52-09
900mm x 225mm



NB52-10
Flat Bar
30mm x 8mm
3000mm long

Decorative Keyed Locks

ALL HANDLES FIT THE STANDARD ELITE BRASS LOCK WHICH IS SUPPLIED WITH A CYLINDER WITH 6 KEYS. PART NUMBER ON LOCK DENOTES THE COLOUR FINISH OF THE HANDLES



NB53-01
Bronze
NB53-02
Copper
NB53-03
Gold



NB53-04
Copper
NB53-05
Black



NB53-06
Copper



NB53-07
Silver

NB53-10
Lock Keeper for
mounting on
brickwork or
timber



NB53-12
Security Gate Lock
designed for gate styles
40, 50 and 60mm thick.
Available in black only.
This lock does not need
a lockbox. Mounts simply
by drilling through the
gate style.



NB53-08
Steel Lock Box
NB53-09
Aluminium Lock Box



NB53-11
Lock Keeper for mounting
on RHS post.

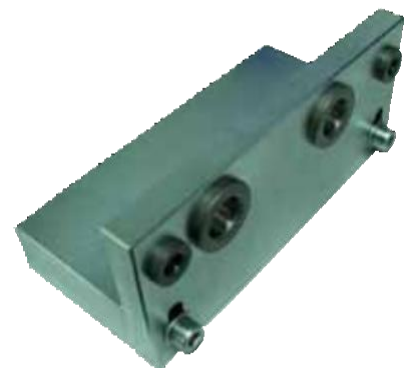

NB53-13
Drilling jig for
setting up lock.

VARIOUS ITEMS



Art. 170/A/5

49 x 43 mm

PAGE 453
INDIA

PAGE 453
INDIA



Art. 170/A/3

92 x 55 mm

PATINA PAINT
PAGE 456

BLACKSMITHS TONGS
462



Art. 171/40

15 x 15 mm

Art. 171/41

20 x 20 mm

due punte
two points

Art. 171/42

25 x 25 mm



Art. 81/4

8 x 8 mm
L 90 mm

Art. 82/4

Ø 8 mm
L 90 mm



Art. 88/L/2

14 x 8 mm |
L 135 mm

PAGE 466 INDIA
20 X 20 300 OFF
25 X 25 X 300 OFF

PAGE 468
INDIA

PAGE 469 INDIA

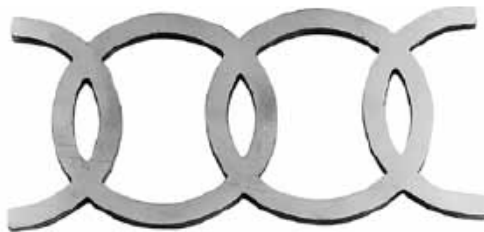

Art. 852/4

spess./thick. 8 mm

H 124 mm - L 129 mm

PAGE 469 INDIA

SAGITTARIO - SAGITTARIUS



spess./thick. 3 mm
Ø 260 mm



Art. 1813/6

14 x 6 mm
H 190 mm
L 960 mm

Art. 1813/5

14 x 6 mm
H 190 mm
L 580 mm

PAGE 477
INDIA

Gate Accessories



NB54-01
105mm x 21mm



NB54-02
125mm x 25mm



NB54-03
150mm x 30mm



NB54-04
175mm x 30mm
16mm Ø thread



NB54-05
230mm x 34mm
20mm Ø thread



NB54-06
210mm
30mm Ø



NB54-07
170mm
25mm Ø



NB54-50
85 X 15
mm
Ball end is
Hammered

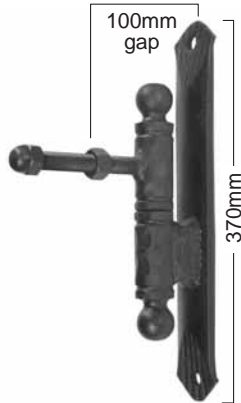

NB54-08



NB54-09
40 x 6mm



NB54-10
40 x 6mm



NB54-11
275 x 95mm
x 5mm



NB54-12
275 x 95mm
x 5mm



NB54-13
270 x
160mm
x 3mm



NB54-14
270 x
160mm
x 3mm



NB54-15
210 x 70
8mm

Lock plates can have holes to suite Elite locks as per page 43

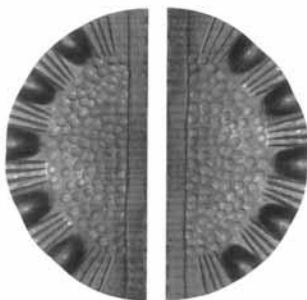

NB54-16
263 x 128
x 3mm

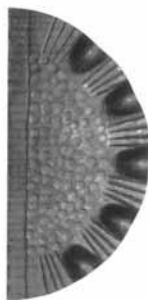

NB54-17
263 x 128
x 3mm



NB54-18
140 x 75mm



NB54-19
145 x 75mm

GATE HINGES & LOCKS



NB54-40

90 X 90 X 4 mm Plate
Suits 30mm bush
Centre of adjustment
= 70 mm



NB54-42 30 MM Bush

Bottom pin 30mm
 nb54-44

KIT ABOVE IS A NB54-65



110 x 110 x 5 mm Plate
 Suits 35 mm Bush
 Centre of adjustment
 = 75 mm



nb54-52 X 35 MM BUSH

bottom pin nb54-54

KIT ABOVE IS A 54-67



- 130 X 130 X 5 mm Plate
- Suits 40 Bush
- Centre of adjustment
- = 90 mm



NB54-62 40 MM BUSH

NB54-64 BOTTOM PIN
 40 MM

KIT ABOVE IS A 54-69

Door & Gate Hinges



NB55-01
(per pair)

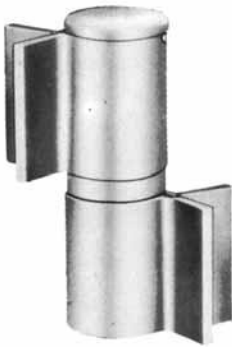
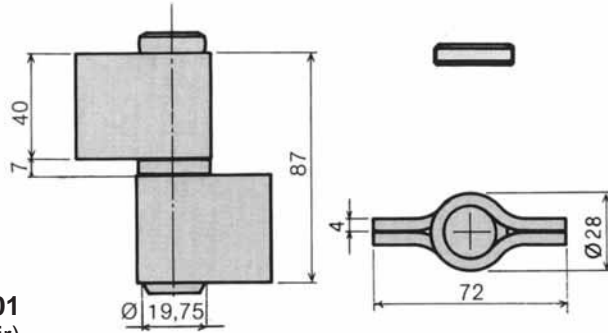

NB55-02
(per pair)

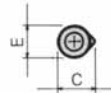
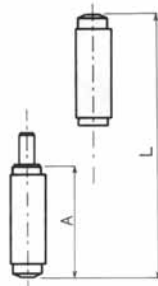
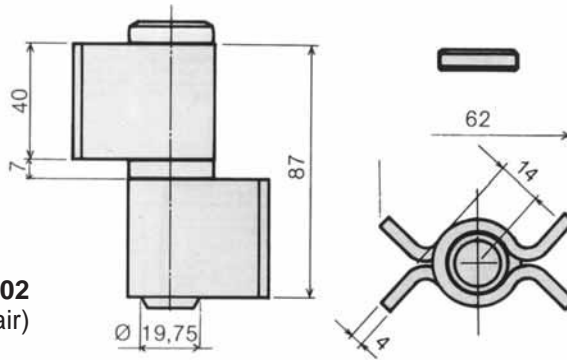

Fixed Pin

	A	C	E	L	D	
NB55-03	80mm	39	16	13	80	7
NB55-04	100mm	48	16	13	98	9
NB55-05	120mm	58	20	16	118.5	9
NB55-06	140mm	68	20	16	138.5	12

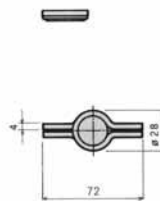
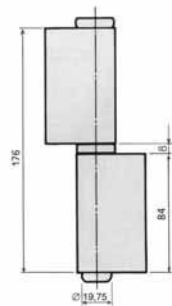

NB55-07
Loose Pin

Double Acting and Single Acting Lever Bolt for locking into place the fixed side of a pair of doors.

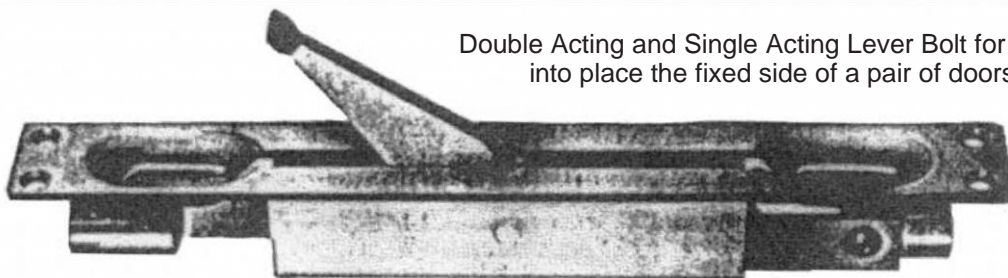

Sliding Gate Accessories



Code

NB56-01

NB56-02

NB56-03 INOX

NB56-04

NB56-05

NB56-06

Steel Zinc Plated Caged Roller

Wheel Diameter	Track Diameter	Load Capacity Per Pair of Wheels
90mm	16mm	380kg
90mm	20mm	380kg
90mm	20mm	380kg
120mm	20mm	440kg
120mm	20mm	800kg
160mm	20mm	1280kg

Stainless Steel



Code

NB56-07

Steel Zinc Plated Flush Mount Caged Roller

Wheel Diameter	Track Diameter	Load Capacity Per Pair of Wheels
80mm	20mm	400kg



Code

NB56-08

NB56-09

NB56-10

NB56-11

NB56-12

NB56-13

Steel Zinc Plated Roller

Wheel Diameter	Track Diameter	Load Capacity Per Pair of Wheels
80mm	16mm	400kg
80mm	20mm	400kg
100mm	16mm	440kg
100mm	20mm	440kg
160mm	20mm	1120kg
200mm	20mm	1200kg



Sliding Gate Stop
Zinc Plated

NB56-14 – Height 123mm
Base Plate 4 hole 100 x 80mm



Nylon Buffer Guide
Zinc Plated

NB56-15W – White
NB56-15B – Black
60 x 40mm – 16mm pin



Nylon Buffer Guide
Stainless Steel

NB56-16 INOX
60 x 40mm
16mm pin

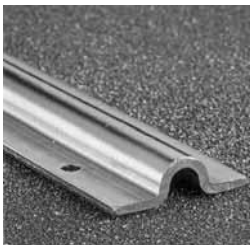

Sliding Gate Track
Zinc Plated

NB56-17 – Track Diameter
19mm
3 metres long

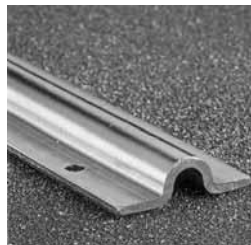

Sliding Gate Track
Aluminium

NB56-18 – Track Diameter
19mm
6 metres long



Swing Gate Stop
Cast Aluminium

NB56-19 – Diameter 125mm
Height of Raised Back 40mm

Sliding Gate Accessories

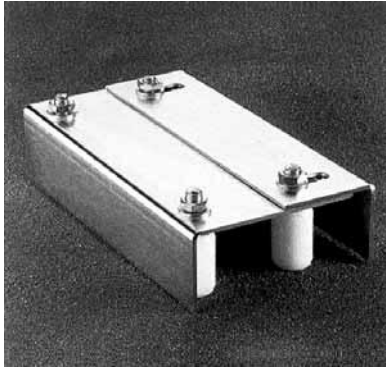

Adjustable Gate Guide
NB57-01 – 220 x 135 x 175mm
 Gate Thickness Adjustment 35-62mm
 Minimum distance from Mounting Side Adjustment.
 Face is 40mm to inside of roller

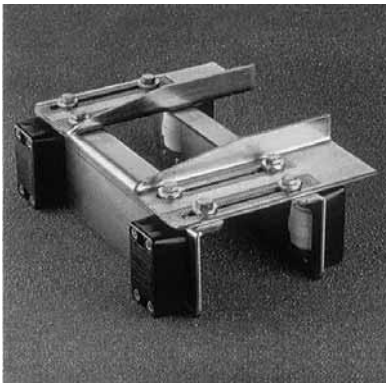

Adjustable Heavy Duty Gate Guide
NB57-02 – 400 x 109 x 229mm
 Gate Thickness Adjustment 36-129mm



Sliding Gate Block
NB57-03 – White
NB57-04 – Black

Detail A

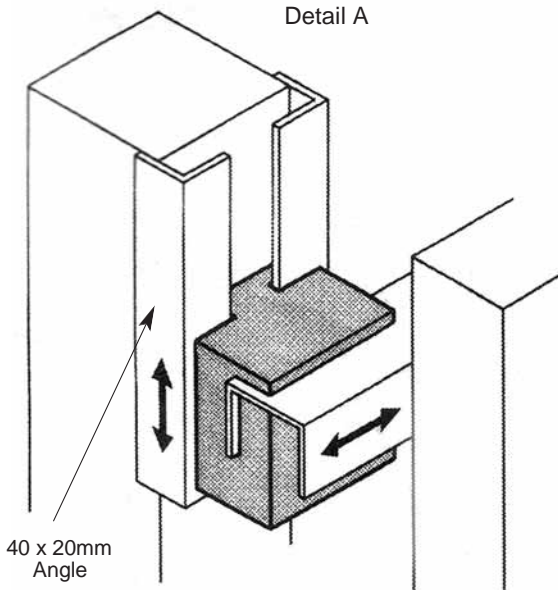

Sliding Gate Block is designed for sloping and uneven driveways. As per Detail A, you can use the Sliding Gate Block on a 75mm square post and use two 40 x 20mm angles for the Block to slide up and down.

If you are coming off a block wall you would use two 'Z' profile sections on one flange of the 'Z', you would bolt to wall, and the other flange the Block would slide on. For this work you will need a 40 x 25 x 2mm channel screwed or welded to the gate. (Channel not supplied).

NB57-05 One pair of 40 x 25 x 3mm Angles 300mm long.

NB57-06 One pair of 20 x 25 x 20mm 'Z' Profile 300mm long.

NB57-07 One piece channel 300mm long.

Cantilevered Sliding Gate System

THIS SYSTEM COMES IN THREE DIFFERENT SIZES –

“MINI” Can support a gate to five metres and weight of 350kg

“PICCOLO” Can support a gate to six metres and weight of 400kg

“GRANDE” Can support a gate to seven metres and weight of 450kg

The instruction manual must be adhered to when calculating position of wheel carriage positioning.

The weight of the channel affixed to the bottom of the gate is calculated in this formula

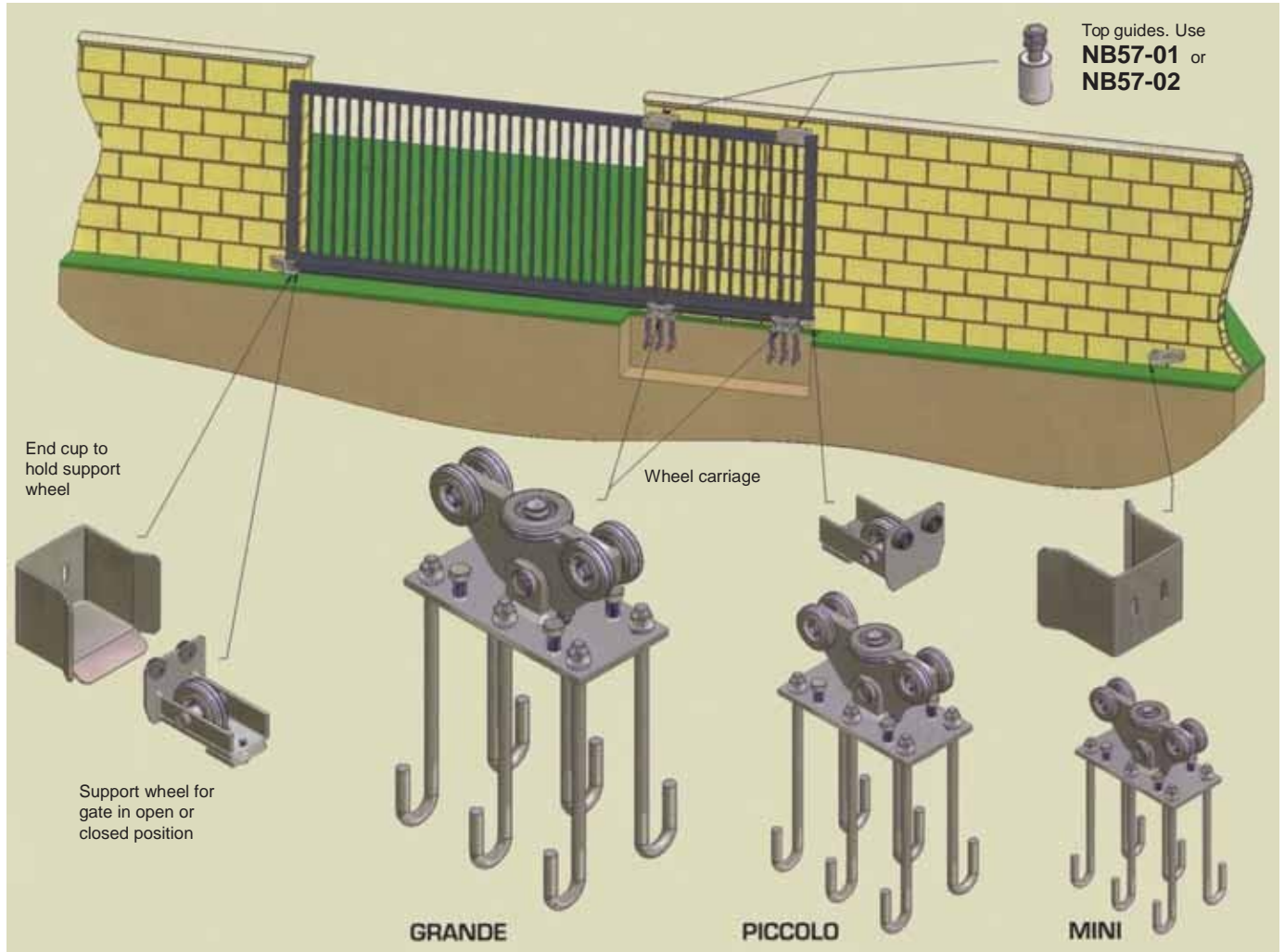

Bottom channel which must be welded or bolted to bottom rail of gate



Catalogues of Components Illustrations of Wrought Iron designs

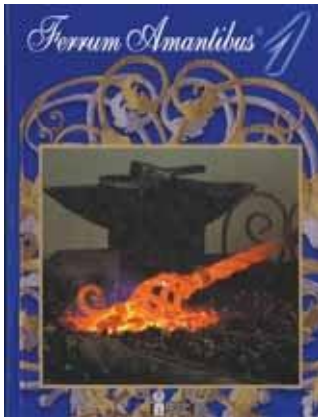

NB59-01
Volume 1

General Catalogue
4000 parts shown. 1562
photographs, 419 pages

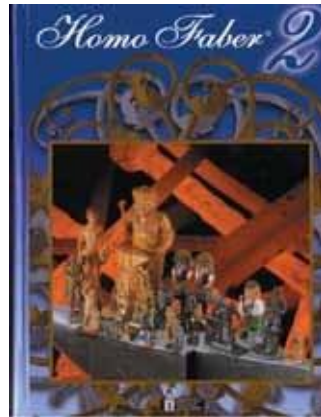

NB59-02
Volume 2

General Catalogue
528 pages of pictures,
3000 parts shown



NB59-03
Volume 3

General Catalogue
700 pages of details
and pictures

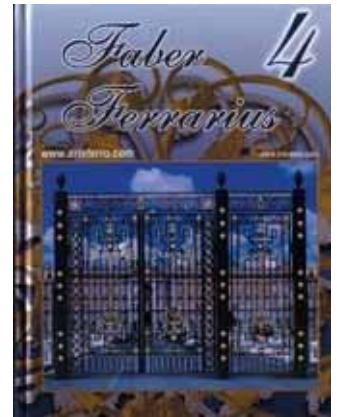

NB59-04
Volume 4

General Catalogue 375
pages and pictures of new
works of wrought iron

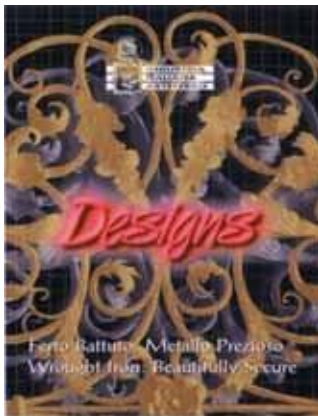

NB59-05

"Designs" 346 pages
of gates, balustrades,
fences and grilles



NB59-06

"Gates" 346 pages
of gate pictures and
drawings

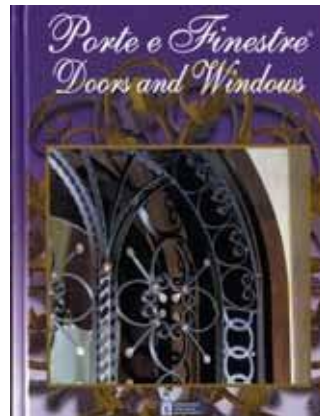

NB59-07

"Doors and windows"
296 pages of doors and
window grilles

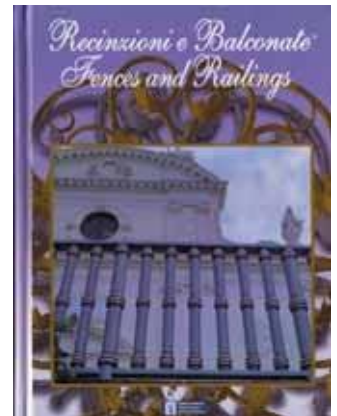

NB59-08

"Fences & Railings" An
impressive 320 pages of
fencing and balustrading



NB59-09

"Video" 45 minute video
of practical instruction
of working with
wrought iron



NB59-10

"CD ROM" An edited version taken
from the full range



NB59-11

"Arteferro CAD 2.5" This CD is a
computer assisted design
program that allows the user to
manipulate images of
components to create beautiful
wrought iron. Runs with Autocad
14 or newer. Needs Windows XP,
Windows 98 & 2000 For Autocad
2000, 2000i, 2002

Patina Paints



Epont Black



Black + Levis Gold



Black + SL11



Black + SL12



Black + SL13



Black + SL15



Black + SL16



Black + SL17



Black + SL18



Black + SL19



Black + SL20



Black + SL21



Black + SL22



Black + SL23



Black + SL + WS10

Custom and old world finishes can be achieved by using different base colours and Patina finishers.

The top set of colours are using black base and bottom set are using silver base.



Metex Silver



Silver + Levis Gold



Silver + SL11



Silver + SL12



Silver + SL13



Silver + SL15



Silver + SL16



Silver + SL17



Silver + SL18



Silver + SL19



Silver + SL20



Silver + SL21



Silver + SL22



Silver + SL23



Silver + SL + WS10

Wrought Aluminium Balusters

ALUMINIUM

ALUMINIUM



NB61-01
950 x 60mm
14mm \varnothing



NB61-02
950 x 60mm
14mm \varnothing



NB61-03
900 x 60mm
14mm \varnothing



NB61-04
900 x 60mm
14mm \varnothing



NB61-05
900 x 60mm
14mm \varnothing



NB61-06
900 x 60mm
14mm \varnothing



NB61-07
1000 x 235mm
14mm \varnothing



NB61-08
1000 x 235mm
14mm \varnothing
NB61-09
1000 x 235mm
14mm \varnothing



NB61-10
1000 x 140mm
12mm \varnothing
NB61-11
1000 x 140mm
14mm \varnothing



NB61-12
1000 x 220mm
12mm \varnothing



NB61-13
1000 x 220mm
12mm \varnothing



NB61-14
1000 x 210mm
12mm \varnothing



NB61-16
1000 x 160mm
12mm \varnothing



NB61-17
1000 x 160mm
12mm \varnothing

Wrought Aluminium Balusters



NB62-01
1000mm
14mm \varnothing



NB62-02
1000mm
14mm \varnothing



NB62-03
1000 x
110mm
14mm \varnothing



NB62-04
1000 x
140mm
14mm \varnothing

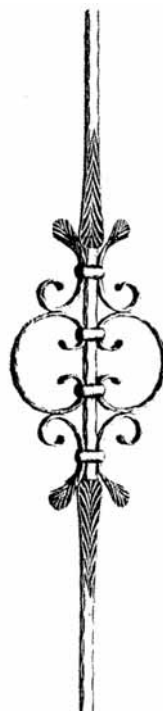

NB62-05
1000 x 225mm
14mm \varnothing



NB62-06
1000 x 60mm
14mm \varnothing



NB62-07
1000 x 220mm
14mm \varnothing



NB62-08
1000 x 100mm
12mm \varnothing
NB62-09
With brass
ornament



NB62-11
900 x 235mm
12mm



NB62-12
1000 x 220mm
12 x 12mm



NB62-13
1000 x 220mm
12 x 12mm



NB62-14
900 x 150mm
12 x 12mm

ALUMINIUM

ALUMINIUM

Wrought Aluminium Balusters

ALUMINIUM

ALUMINIUM



NB63-01
870 x 350mm
12 x 6mm \varnothing



NB63-02
870 x 350mm
12 x 6mm \varnothing

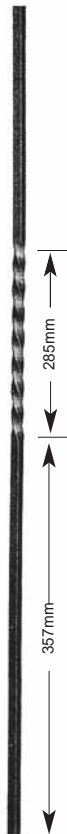

NB63-03
1000mm
12mm \varnothing
NB63-04
1000mm
14mm \varnothing

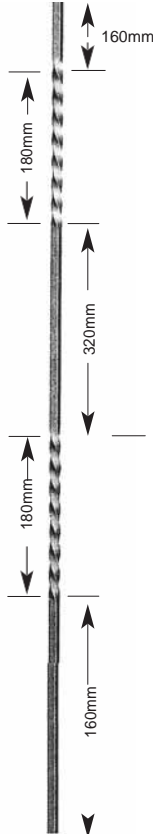

NB63-05
1000mm
12mm \varnothing
NB63-06
1000mm
14mm \varnothing



NB63-07
1000mm
12mm \varnothing
NB63-08
1000mm
14mm \varnothing



NB63-09
1000 x
80mm
14 x 14mm



NB63-10
1000 x 220mm
14 x 14mm



NB63-11
900 x 230mm
12 x 12mm



NB63-12
900 x 230mm
12 x 12mm



NB63-13
900 x 230mm
12 x 12mm



NB63-14
900 x 230mm
12 x 12mm

Wrought Aluminium Balusters



NB64-01
 14mm
 1000mm



NB64-02
 14mm
 1000mm



NB64-03
 12 x 12mm
 1000mm
NB64-04
 14 x 14mm
 1000mm



NB64-05
 12 x 12mm
 1000mm
NB64-06
 14 x 14mm
 1000mm



NB64-07
 12 x 12mm
 1000mm
NB64-08
 14 x 14mm
 1000mm



NB64-09
 12 x 12mm
 1000mm
NB64-10
 14 x 14mm
 1000mm



NB64-11
 1200mm
 25mm



NB64-12
 1200mm
 25mm



NB64-13
 1200mm
 25mm



NB64-14
 50 x 15mm



NB64-15
 Suits 04 & 05



NB64-16
 Suits 04 & 05



NB64-17
 Suits 04 & 05



NB64-18
 Suits 04 & 05

Solid Top Rail & Ends

ALUMINIUM

ALUMINIUM

Aluminium Hammered Sections



NB65-01
25 x 25mm
NB65-02
32 x 32mm
NB65-03
40 x 40mm
NB65-04
50 x 50mm
NB65-05
50 x 25mm



NB65-06
25 x 10mm
NB65-07
40 x 10mm
NB65-08
50 x 10mm



NB65-09
12 x 12mm
NB65-10
14 x 14mm
NB65-11
16 x 16mm
NB65-12
20 x 20mm
NB65-13
25 x 25mm

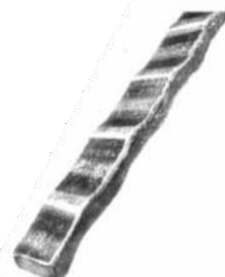

NB65-15 25 x 10mm
NB65-16 40 x 10mm
NB65-17 50 x 10mm
2 Sides x Hammered
NB65-18 12 x 12mm
NB65-19 14 x 14mm
NB65-20 16 x 16mm
4 Sides x Hammered
NB65-21 12 x 12mm
NB65-22 14 x 14mm
NB65-23 16 x 16mm



TATTOO BAR
NB65-24
40 X 10mm



NB65-25
190 x 100mm
14 x 14mm



NB65-26
Ø100mm
NB65-27
Ø115mm
NB65-28
Ø100mm
12 x 6mm
NB65-29
Ø115mm
12 x 6mm



NB65-30
255mm Round
12 x 6mm



NB65-31
300mm Round
12 x 6mm



NB65-32
255 x 270mm
14 x 14mm



NB65-33
118mm Round



NB65-34
120mm Round



Collar Material
NB65-35
14 x 4mm

wide size



Bent Collars to fit
NB65-36
26 x 14mm
NB65-37
14 x 14mm
NB65-38
12 x 12mm

INDIA 770/6
150 X 105 C SCROLL

Aluminium Scrolls

Material 12 x 6mm unless noted.



NB66-01
150 x 70mm
NB66-02
225 x 100mm
NB66-03
300 x 120mm



NB66-04
225 x 170mm
14 x 14mm



NB66-05
95 x 60mm
NB66-06
105 x 70mm
NB66-07
115 x 75mm
NB66-08
120 x 70mm



NB66-09
130 x 70mm
NB66-10
150 x 75mm
NB66-11
140 x 75mm
NB66-12
240 x 125mm



NB66-13
160 x 250mm
NB66-14
250 x 150mm



NB66-15
320 x 100mm
NB66-16
330 x 115mm
NB66-17
350 x 120mm
NB66-18
350 x 120mm
12 x 12mm



NB66-19
150 x 70mm
NB66-20
250 x 100mm
NB66-21
250 x 110mm
NB66-22
300 x 120mm
NB66-23
350 x 120mm
12 x 12mm



NB66-24
330 x 115mm
12 mm \varnothing



NB66-25
150 x 105mm



NB66-26
230 x 50mm



NB66-27
105 x 60mm
Tail left hand



NB66-28
105 x 60mm
Tail right hand

The scrolls listed above are mainly our stock items.
We can custom make scrolls up to 50 x 12mm flat or 25 x 25mm solid

Gate Tops



NB66-29
1310 x 420mm
20 x 6mm \varnothing
NB66-30
1100 x 420mm
20 x 6mm \varnothing



NB66-31
900 x 300mm
20 x 6mm

ALUMINIUM

Aluminium Articles



NB67-01
11 x 11mm base
125 x 60mm

NB67-02
14 x 14mm base
125 x 60mm

NB67-03
16 x 16mm base
150 x 74mm

NB67-04
25 x 25mm base
178 x 95mm



NB67-05
109 x 42 x 3mm
As shown
NB67-06
Right hand



NB67-07
65 x 75 x 3mm
As shown
NB67-08
Right hand



NB67-09
110 x 50 x 3mm



NB67-10
64 x 3mm



NB67-11
20mm ball

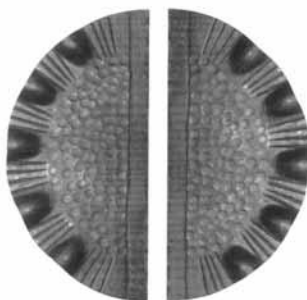

NB67-12
275 x
128mm

NB67-13
275 x
128mm

*With holes to suit
Elite locks as per page 58.*



NB67-14
291 x 209 x 4mm

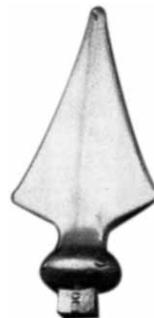

NB67-15
140mm height



NB67-16
65 x 40mm
Ø 16.5mm



NB67-17
Ø 39mm x
24mm
14.5mm

square hole
NB67-18
16.5mm
round hole



NB67-19
123 x 33mm
Ø 16.5mm

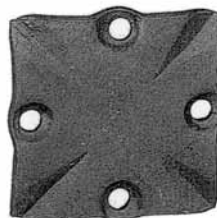

NB67-20
80 x 80 x 8mm



NB67-21
123mm
Ø 4mm

ALUMINIUM ITEMS



AB-61

Ø 14 mm

H 900 mm L 350 mm



